



Dual, Temperature-Controlled Resistors with Internally Calibrated Monitors

DS1859

General Description

The DS1859 dual, temperature-controlled, nonvolatile (NV) variable resistors with three monitors consists of two 50kΩ or two 20kΩ, 256-position, linear, variable resistors; three analog monitor inputs (MON1, MON2, MON3); and a direct-to-digital temperature sensor. The device provides an ideal method for setting and temperature-compensating bias voltages and currents in control applications using minimal circuitry. The variable resistor settings are stored in EEPROM memory and can be accessed over the 2-wire serial bus.

Features

- ◆ SFF-8472 Compatible
- ◆ Five Monitored Channels (Temperature, V_{CC}, MON1, MON2, MON3)
- ◆ Three External Analog Inputs (MON1, MON2, MON3) That Support Internal and External Calibration
- ◆ Scalable Dynamic Range for External Analog Inputs
- ◆ Internal Direct-to-Digital Temperature Sensor
- ◆ Alarm and Warning Flags for All Monitored Channels
- ◆ Two 50kΩ or Two 20kΩ, Linear, 256-Position, Nonvolatile Temperature-Controlled Variable Resistors
- ◆ Resistor Settings Changeable Every 2°C
- ◆ Access to Monitoring and ID Information Configurable with Separate Device Addresses
- ◆ 2-Wire Serial Interface
- ◆ Two Buffers with TTL/CMOS-Compatible Inputs and Open-Drain Outputs
- ◆ Operates from a 3.3V or 5V Supply
- ◆ Operating Temperature Range of -40°C to +95°C

Applications

- Optical Transceivers
- Optical Transponders
- Instrumentation and Industrial Controls
- RF Power Amps
- Diagnostic Monitoring

Typical Operating Circuit

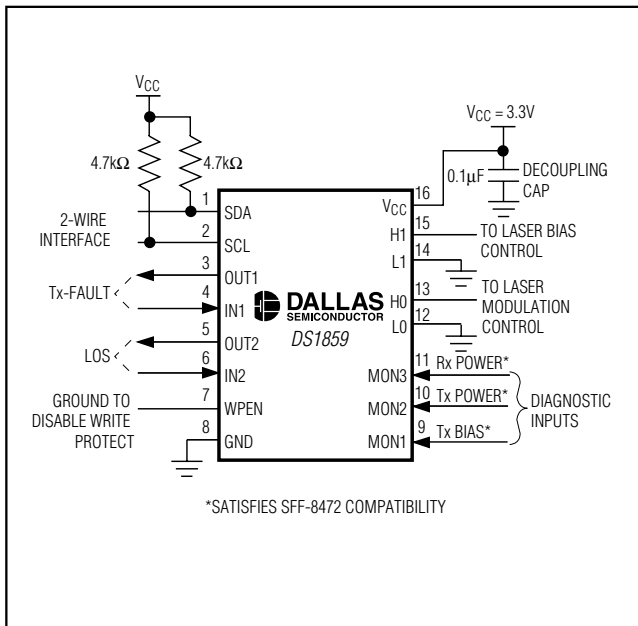

Ordering Information

| PART | RESISTANCE | PIN-PACKAGE |
|--------------|------------|-------------|
| DS1859B-020 | 20kΩ | 16 CSBGA |
| DS1859B-020+ | 20kΩ | 16 CSBGA |
| DS1859B-050 | 50kΩ | 16 CSBGA |
| DS1859B-050+ | 50kΩ | 16 CSBGA |

+Denotes lead-free package.

Ordering Information continued at end of data sheet.

Pin Configurations

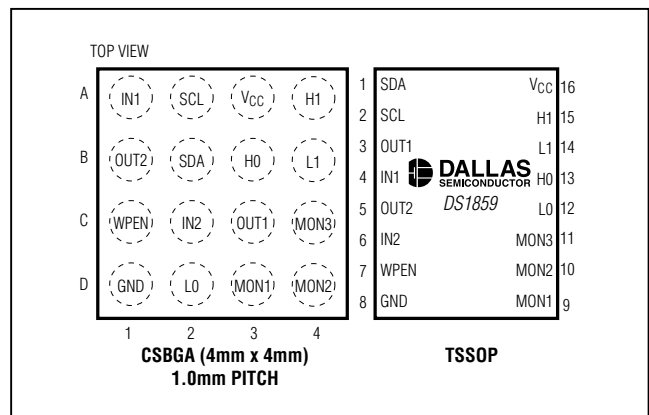

For pricing delivery, and ordering information please contact Maxim/Dallas Direct! at 1-888-629-4642, or visit Maxim's website at www.maxim-ic.com.

Dual, Temperature-Controlled Resistors with Internally Calibrated Monitors

ABSOLUTE MAXIMUM RATINGS

Voltage Range on V_{CC} Relative to Ground-0.5V to +6.0V
 Voltage Range on Inputs Relative to Ground*-0.5V to $V_{CC} + 0.5V$
 Voltage Range on Resistor Inputs Relative to Ground*-0.5V to $V_{CC} + 0.5V$
 Current into Resistors.....5mA

Operating Temperature Range-40°C to +95°C
 Programming Temperature Range0°C to +70°C
 Storage Temperature Range-55°C to +125°C
 Soldering TemperatureSee IPC/JEDEC J-STD-020A

*Not to exceed 6.0V.

Stresses beyond those listed under "Absolute Maximum Ratings" may cause permanent damage to the device. These are stress ratings only, and functional operation of the device at these or any other conditions beyond those indicated in the operational sections of the specifications is not implied. Exposure to absolute maximum rating conditions for extended periods may affect device reliability.

RECOMMENDED DC OPERATING CONDITIONS

($T_A = -40^\circ\text{C}$ to $+95^\circ\text{C}$, unless otherwise noted.)

| PARAMETER | SYMBOL | CONDITIONS | MIN | TYP | MAX | UNITS |
|----------------------------------|------------|---------------|---------------------|-------|----------------------|---------------|
| Supply Voltage | V_{CC} | (Note 1) | 2.85 | | 5.5 | V |
| Input Logic 1 (SDA, SCL, WPEN) | V_{IH} | (Note 2) | $0.7 \times V_{CC}$ | | $V_{CC} + 0.3$ | V |
| Input Logic 0 (SDA, SCL, WPEN) | V_{IL} | (Note 2) | -0.3 | | $+0.3 \times V_{CC}$ | V |
| Resistor Inputs (L0, L1, H0, H1) | | | -0.3 | | $V_{CC} + 0.3$ | V |
| Resistor Current | I_{RES} | | -3 | | +3 | mA |
| High-Z Resistor Current | I_{ROFF} | | | 0.001 | 0.1 | μA |
| Input Logic Levels (IN1, IN2) | | Input logic 1 | 1.5 | | | V |
| | | Input logic 0 | | | 0.9 | |

DC ELECTRICAL CHARACTERISTICS

($V_{CC} = 2.85\text{V}$ to 5.5V , $T_A = -40^\circ\text{C}$ to $+95^\circ\text{C}$, unless otherwise noted.)

| PARAMETER | SYMBOL | CONDITIONS | MIN | TYP | MAX | UNITS |
|--|------------|-----------------------------|--------|--------|--------|-----------|
| Supply Current | I_{CC} | (Note 3) | | 1 | 2 | mA |
| Input Leakage | I_{IL} | | -200 | | +200 | nA |
| Low-Level Output Voltage (SDA, OUT1, OUT2) | V_{OL1} | 3mA sink current | 0 | | 0.4 | V |
| | V_{OL2} | 6mA sink current | 0 | | 0.6 | |
| Full-Scale Input (MON1, MON2, MON3) | | At factory setting (Note 4) | 2.4875 | 2.5 | 2.5125 | V |
| Full-Scale V_{CC} Monitor | | At factory setting (Note 5) | 6.5208 | 6.5536 | 6.5864 | V |
| I/O Capacitance | $C_{I/O}$ | | | | 10 | pF |
| WPEN Pullup | R_{WPEN} | | 40 | 65 | 100 | $k\Omega$ |
| Digital Power-On Reset | POD | | 1.0 | | 2.2 | V |
| Analog Power-On Reset | POA | | 2.0 | | 2.6 | V |

Dual, Temperature-Controlled Resistors with Internally Calibrated Monitors

DS1859

ANALOG RESISTOR CHARACTERISTICS

(V_{CC} = 2.85V to 5.5V, T_A = -40°C to +95°C, unless otherwise noted.)

| PARAMETER | SYMBOL | CONDITIONS | MIN | TYP | MAX | UNITS |
|--------------------------------|--------|------------------------|------|------|------|--------|
| Position 00h Resistance (50kΩ) | | T _A = +25°C | 0.65 | 1.0 | 1.35 | kΩ |
| Position FFh Resistance (50kΩ) | | T _A = +25°C | 40 | 50 | 60 | kΩ |
| Position 00h Resistance (20kΩ) | | T _A = +25°C | 0.20 | 0.40 | 0.55 | kΩ |
| Position FFh Resistance (20kΩ) | | T _A = +25°C | 16 | 20 | 24 | kΩ |
| Absolute Linearity | | (Note 6) | -2 | | +2 | LSB |
| Relative Linearity | | (Note 7) | -1 | | +1 | LSB |
| Temperature Coefficient | | (Note 8) | | 50 | | ppm/°C |

ANALOG VOLTAGE MONITORING

(V_{CC} = 2.85V to 5.5V, T_A = -40°C to +95°C, unless otherwise noted.)

| PARAMETER | SYMBOL | CONDITIONS | MIN | TYP | MAX | UNITS |
|--|--------------------|--------------------|-----|------|-----|-------------------|
| Input Resolution | ΔV _{MON} | | | 610 | | μV |
| Supply Resolution | ΔV _{CC} | | | 1.6 | | mV |
| Input/Supply Accuracy (MON1, MON2, MON3, V _{CC}) | ACC | At factory setting | | 0.25 | 0.5 | % FS (full scale) |
| Update Rate for MON1, MON2, MON3, Temp, or V _{CC} | t _{frame} | | | 30 | 45 | ms |
| Input/Supply Offset (MON1, MON2, MON3, V _{CC}) | V _{OS} | (Note 14) | | 0 | 5 | LSB |

DIGITAL THERMOMETER

(V_{CC} = 2.85V to 5.5V, T_A = -40°C to +95°C, unless otherwise noted.)

| PARAMETER | SYMBOL | CONDITIONS | MIN | TYP | MAX | UNITS |
|-------------------|------------------|----------------|-----|-----|------|-------|
| Thermometer Error | T _{ERR} | -40°C to +95°C | | | ±3.0 | °C |

NONVOLATILE MEMORY CHARACTERISTICS

(V_{CC} = 2.85V to 5.5V)

| PARAMETER | SYMBOL | CONDITIONS | MIN | TYP | MAX | UNITS |
|---------------|--------|------------|--------|-----|-----|-------|
| EEPROM Writes | | +70°C | 50,000 | | | |

Dual, Temperature-Controlled Resistors with Internally Calibrated Monitors

AC ELECTRICAL CHARACTERISTICS

($V_{CC} = 2.85V$ to $5.5V$, $T_A = -40^{\circ}C$ to $+95^{\circ}C$, unless otherwise noted. See Figure 6.)

| PARAMETER | SYMBOL | CONDITIONS | MIN | TYP | MAX | UNITS |
|--|--------------|---------------------------------|---------------|-----|------|---------|
| SCL Clock Frequency | f_{SCL} | Fast mode (Note 9) | 0 | | 400 | kHz |
| | | Standard mode (Note 9) | 0 | | 100 | |
| Bus Free Time Between STOP and START Condition | t_{BUF} | Fast mode (Note 9) | 1.3 | | | μs |
| | | Standard mode (Note 9) | 4.7 | | | |
| Hold Time (Repeated) START Condition | $t_{HD:STA}$ | Fast mode (Notes 9, 10) | 0.6 | | | μs |
| | | Standard mode (Notes 9, 10) | 4.0 | | | |
| LOW Period of SCL Clock | t_{LOW} | Fast mode (Note 9) | 1.3 | | | μs |
| | | Standard mode (Note 9) | 4.7 | | | |
| HIGH Period of SCL Clock | t_{HIGH} | Fast mode (Note 9) | 0.6 | | | μs |
| | | Standard mode (Note 9) | 4.0 | | | |
| Data Hold Time | $t_{HD:DAT}$ | Fast mode (Notes 9, 11, 12) | 0 | | 0.9 | μs |
| | | Standard mode (Notes 9, 11, 12) | 0 | | | |
| Data Setup Time | $t_{SU:DAT}$ | Fast mode (Note 9) | 100 | | | ns |
| | | Standard mode (Note 9) | 250 | | | |
| START Setup Time | $t_{SU:STA}$ | Fast mode (Note 9) | 0.6 | | | μs |
| | | Standard mode (Note 9) | 4.7 | | | |
| Rise Time of Both SDA and SCL Signals | t_R | Fast mode (Note 13) | $20 + 0.1C_B$ | | 300 | ns |
| | | Standard mode (Note 13) | $20 + 0.1C_B$ | | 1000 | |
| Fall Time of Both SDA and SCL Signals | t_F | Fast mode (Note 13) | $20 + 0.1C_B$ | | 300 | ns |
| | | Standard mode (Note 13) | $20 + 0.1C_B$ | | 300 | |
| Setup Time for STOP Condition | $t_{SU:STO}$ | Fast mode | 0.6 | | | μs |
| | | Standard mode | 4.0 | | | |
| Capacitive Load for Each Bus Line | C_B | (Note 13) | | | 400 | pF |
| EEPROM Write Time | t_W | (Note 14) | | 10 | 20 | ms |

Note 1: All voltages are referenced to ground.

Note 2: I/O pins of fast-mode devices must not obstruct the SDA and SCL lines if V_{CC} is switched off.

Note 3: SDA and SCL are connected to V_{CC} and all other input signals are connected to well-defined logic levels.

Note 4: Full Scale is user programmable. The maximum voltage that the MON inputs read is approximately Full Scale, even if the voltage on the inputs is greater than Full Scale.

Note 5: This voltage defines the maximum range of the analog-to-digital converter voltage, not the maximum V_{CC} voltage.

Note 6: Absolute linearity is the difference of measured value from expected value at DAC position. The expected value is a straight line from measured minimum position to measured maximum position.

Note 7: Relative linearity is the deviation of an LSB DAC setting change vs. the expected LSB change. The expected LSB change is the slope of the straight line from measured minimum position to measured maximum position.

Note 8: See the *Typical Operating Characteristics*.

Note 9: A fast-mode device can be used in a standard-mode system, but the requirement $t_{SU:DAT} > 250ns$ must then be met. This is automatically the case if the device does not stretch the LOW period of the SCL signal. If such a device does stretch the LOW period of the SCL signal, it must output the next data bit to the SDA line $t_{RMAX} + t_{SU:DAT} = 1000ns + 250ns = 1250ns$ before the SCL line is released.

Dual, Temperature-Controlled Resistors with Internally Calibrated Monitors

Note 10: After this period, the first clock pulse is generated.

Note 11: The maximum $t_{HD:DAT}$ only has to be met if the device does not stretch the LOW period (t_{LOW}) of the SCL signal.

Note 12: A device must internally provide a hold time of at least 300ns for the SDA signal (see the $V_{IH\ MIN}$ of the SCL signal) to bridge the undefined region of the falling edge of SCL.

Note 13: C_B —total capacitance of one bus line, timing referenced to $0.9 \times V_{CC}$ and $0.1 \times V_{CC}$.

Note 14: Guaranteed by design.

Typical Operating Characteristics

($V_{CC} = 5.0V$, $T_A = +25^\circ C$, for both 50k Ω and 20k Ω versions, unless otherwise noted.)

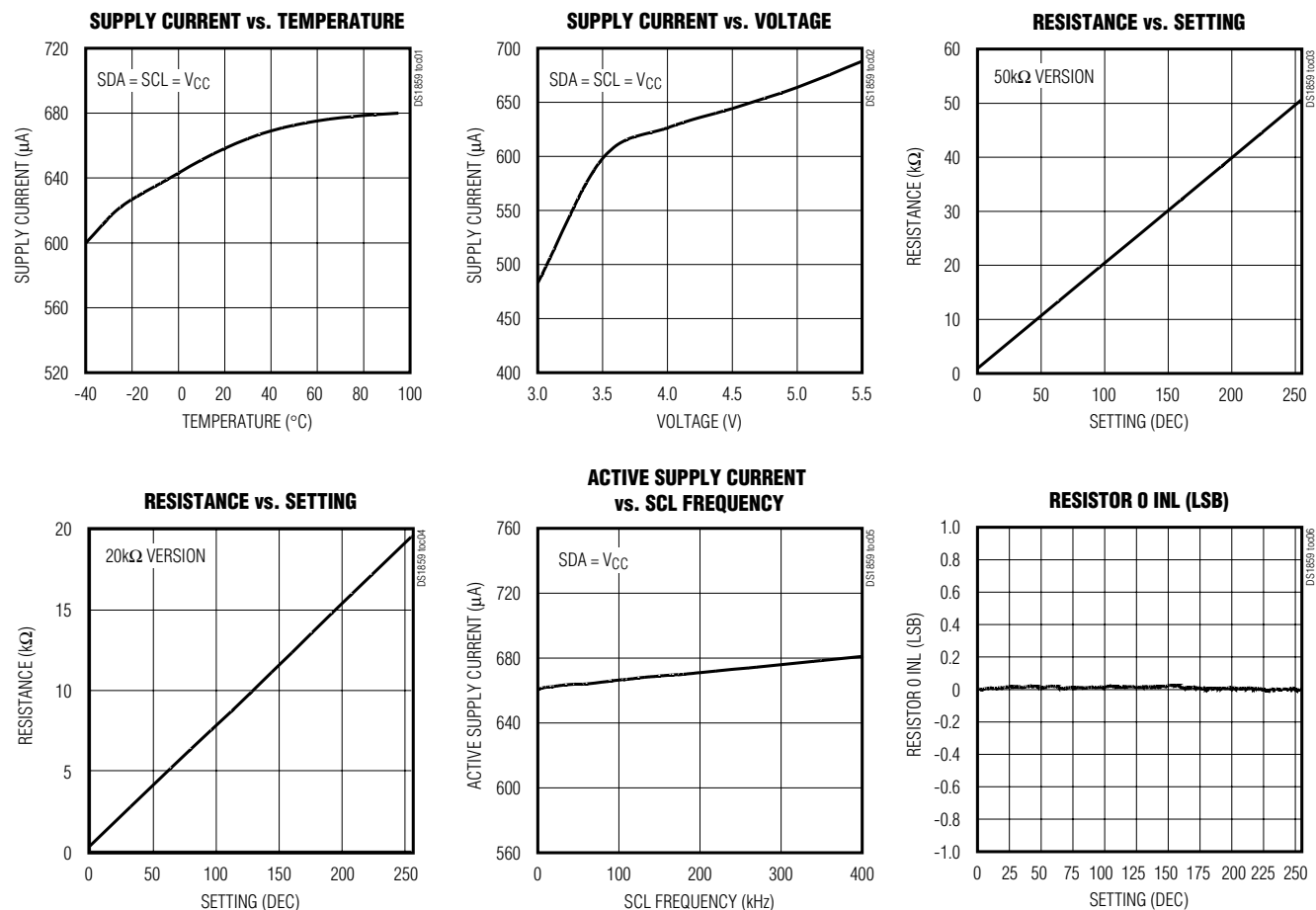

Dual, Temperature-Controlled Resistors with Internally Calibrated Monitors

Typical Operating Characteristics (continued)

(V_{CC} = 5.0V, T_A = +25°C, for both 50kΩ and 20kΩ versions, unless otherwise noted.)

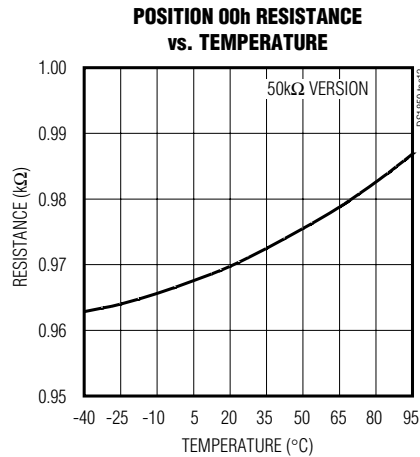
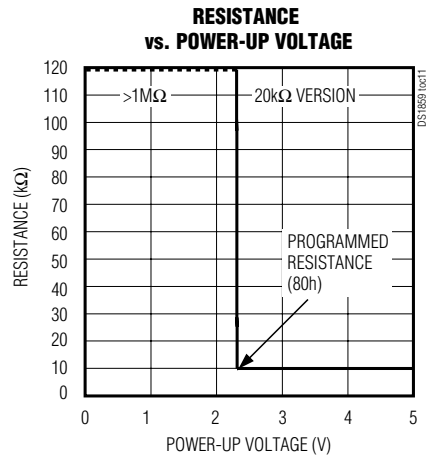
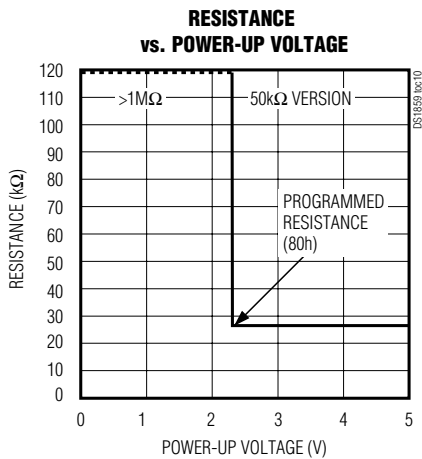
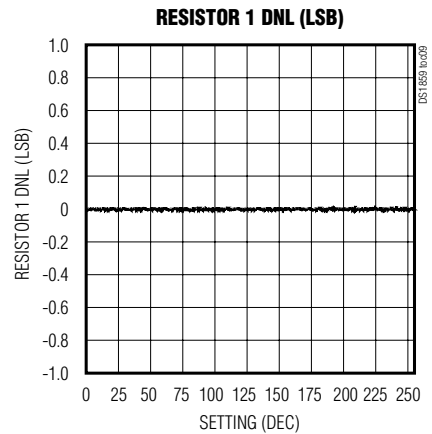
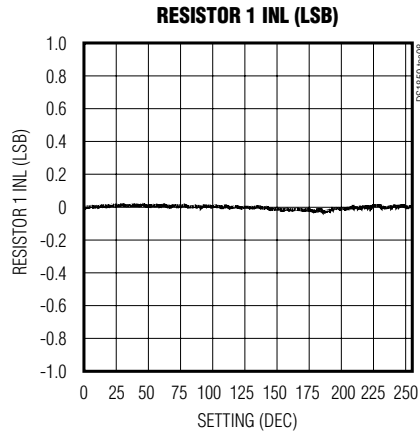
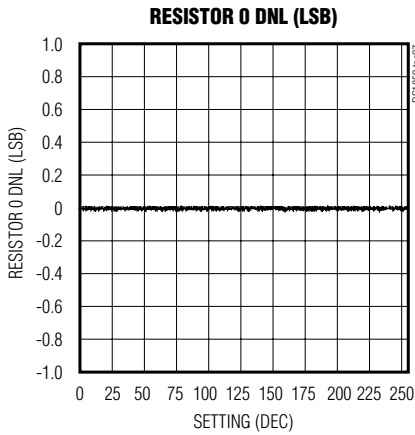

Dual, Temperature-Controlled Resistors with Internally Calibrated Monitors

DS1859

Typical Operating Characteristics (continued)

($V_{CC} = 5.0V$, $T_A = +25^\circ C$, for both 50k Ω and 20k Ω versions, unless otherwise noted.)

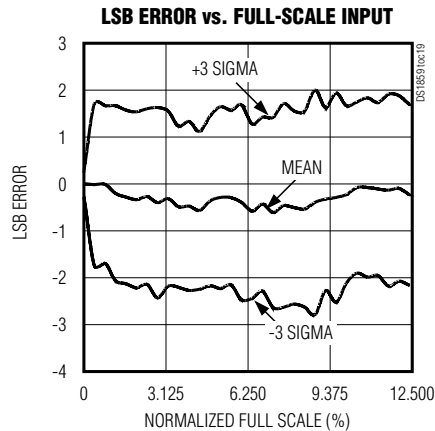
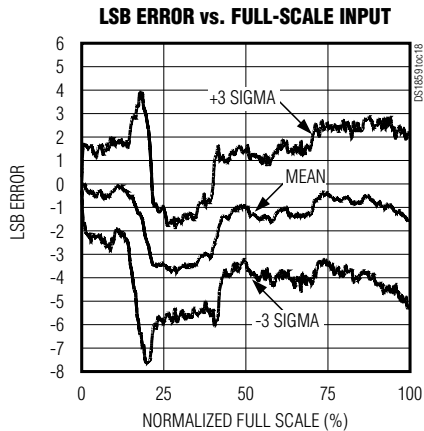
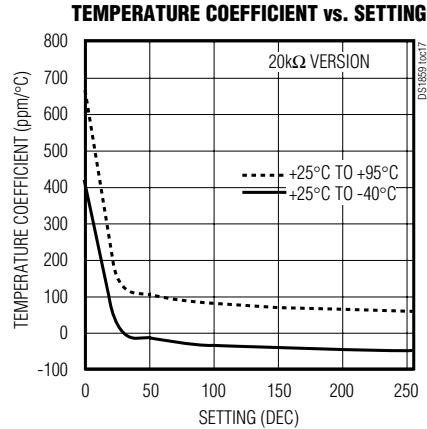
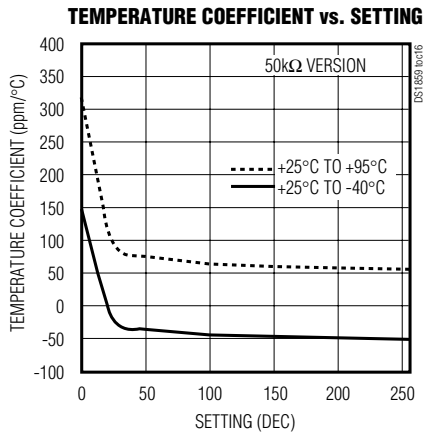
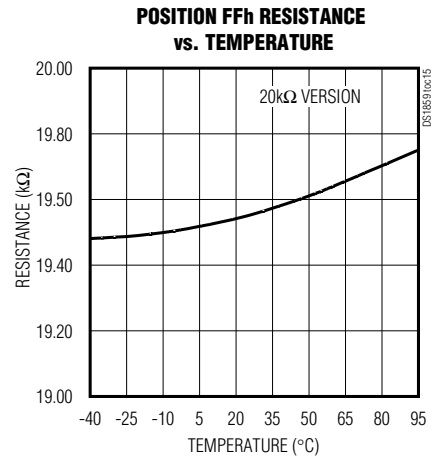
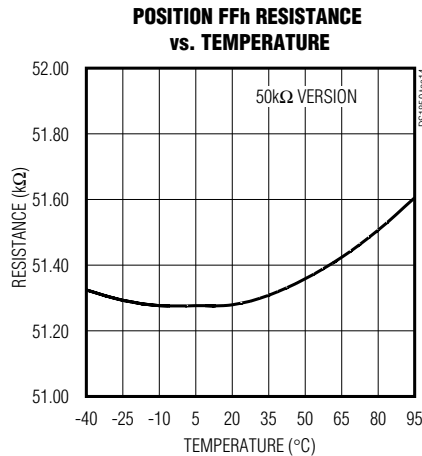
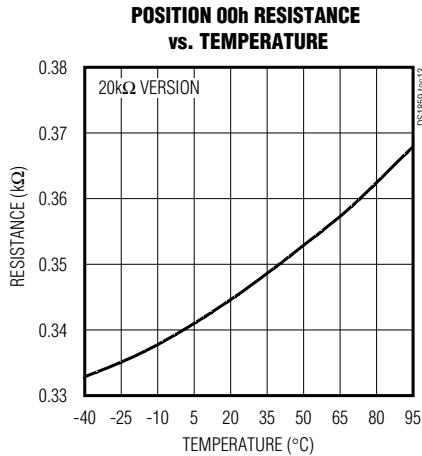

Dual, Temperature-Controlled Resistors with Internally Calibrated Monitors

Pin Description

| PIN | BALL | NAME | FUNCTION |
|-----|------|-----------------|---|
| 1 | B2 | SDA | 2-Wire Serial Data I/O Pin. Transfers serial data to and from the device. |
| 2 | A2 | SCL | 2-Wire Serial Clock Input. Clocks data into and out of the device. |
| 3 | C3 | OUT1 | Open-Drain Buffer Output |
| 4 | A1 | IN1 | TTL/CMOS-Compatible Input to Buffer |
| 5 | B1 | OUT2 | Open-Drain Buffer Output |
| 6 | C2 | IN2 | TTL/CMOS-Compatible Input to Buffer |
| 7 | C1 | WPEN | Write Protect Enable. The device is not write protected if WPEN is connected to ground. This pin has an internal pullup (R _{WPEN}). See Table 6. |
| 8 | D1 | GND | Ground |
| 9 | D3 | MON1 | External Analog Input |
| 10 | D4 | MON2 | External Analog Input |
| 11 | C4 | MON3 | External Analog Input |
| 12 | D2 | L0 | Low-End Resistor 0 Terminal. It is not required that the low-end terminals be connected to a potential less than the high-end terminals of the corresponding resistor. Voltage applied to any of the resistor terminals cannot exceed the power-supply voltage, V _{CC} , or go below ground. |
| 13 | B3 | H0 | High-End Resistor 0 Terminal. It is not required that the high-end terminals be connected to a potential greater than the low-end terminals of the corresponding resistor. Voltage applied to any of the resistor terminals cannot exceed the power-supply voltage, V _{CC} , or go below ground. |
| 14 | B4 | L1 | Low-End Resistor 1 Terminal |
| 15 | A4 | H1 | High-End Resistor 1 Terminal |
| 16 | A3 | V _{CC} | Supply Voltage |

Detailed Description

The user can read the registers that monitor the V_{CC}, MON1, MON2, MON3, and temperature analog signals. After each signal conversion, a corresponding bit is set that can be monitored to verify that a conversion has occurred. The signals also have alarm and warning flags that notify the user when the signals go above or below the user-defined value. Interrupts can also be set for each signal.

The position values of each resistor can be independently programmed. The user can assign a unique value to each resistor for every 2°C increment over the -40°C to +102°C range.

Two buffers are provided to convert logic-level inputs into open-drain outputs. Typically, these buffers are used to implement transmit (Tx) fault and loss-of-signal (LOS) functionality. Additionally, OUT1 can be asserted in the event that one or more of the monitored values go beyond user-defined limits.

Dual, Temperature-Controlled Resistors with Internally Calibrated Monitors

DS1859

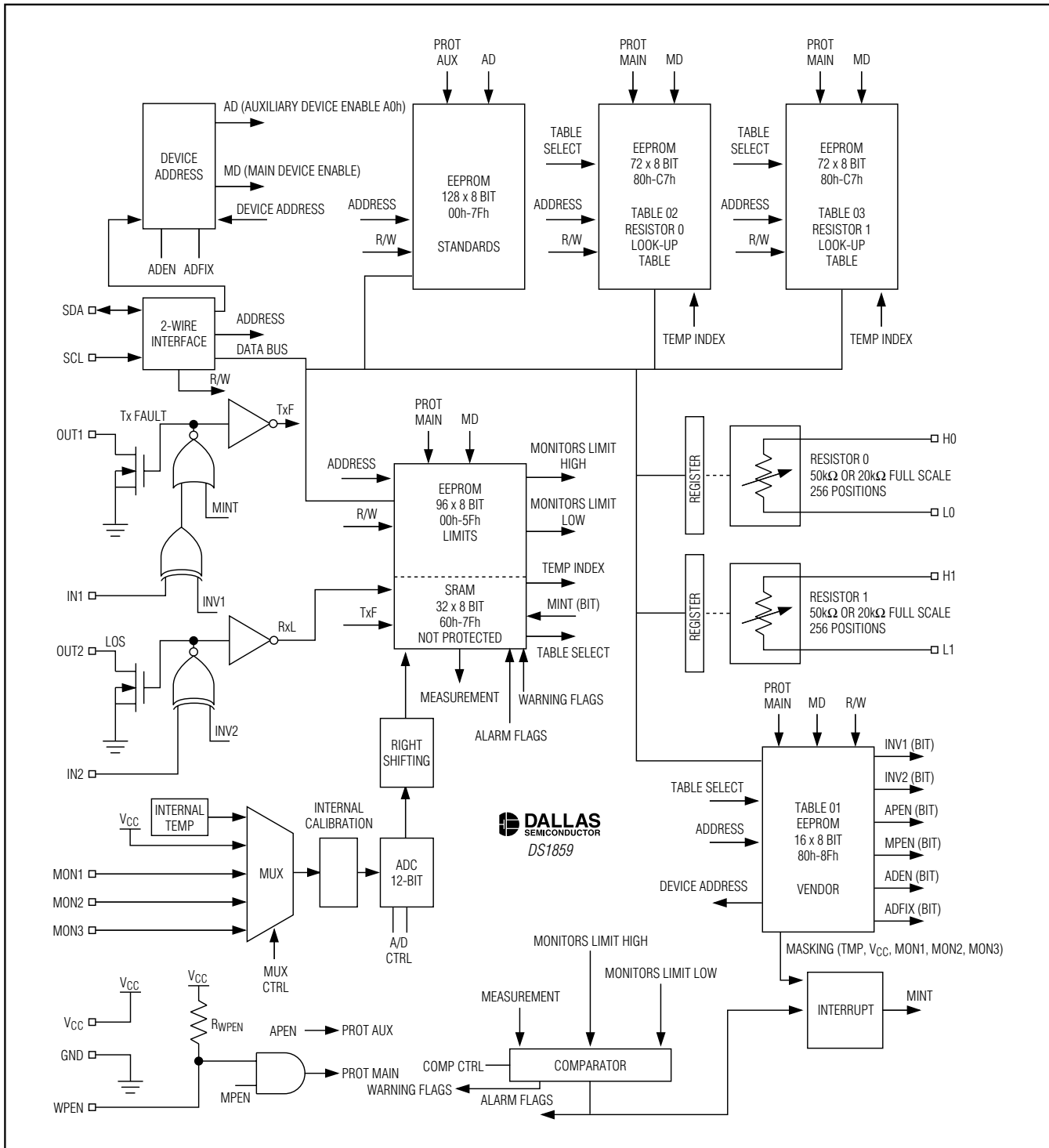

Figure 1. Block Diagram

Dual, Temperature-Controlled Resistors with Internally Calibrated Monitors

Table 1. Scales for Monitor Channels at Factory Setting

| SIGNAL | +FS SIGNAL | +FS (hex) | -FS SIGNAL | -FS (hex) |
|-----------------|------------|-----------|------------|-----------|
| Temperature | 127.984°C | 7FFC | -128°C | 8000 |
| V _{CC} | 6.5528V | FFF8 | 0V | 0000 |
| MON1 | 2.4997V | FFF8 | 0V | 0000 |
| MON2 | 2.4997V | FFF8 | 0V | 0000 |
| MON3 | 2.4997V | FFF8 | 0V | 0000 |

Table 2. Signal Comparison

| SIGNAL | FORMAT |
|-----------------|------------------|
| V _{CC} | Unsigned |
| MON1 | Unsigned |
| MON2 | Unsigned |
| MON3 | Unsigned |
| Temperature | Two's complement |

Monitored Signals

Each signal (V_{CC}, MON1, MON2, MON3, and temperature) is available as a 16-bit value with 12-bit accuracy (left-justified) over the serial bus. See Table 1 for signal scales and Table 2 for signal format. The four LSBs should be masked when calculating the value.

For the 20kΩ version, the 3 LSBs are internally masked with 0s.

The signals are updated every frame rate (t_{frame}) in a round-robin fashion.

The comparison of all five signals with the high and low user-defined values are done automatically. The corresponding flags are set to 1 within a specified time of the occurrence of an out-of-limit condition.

Calculating Signal Values

The LSB = 100μV for V_{CC}, and the LSB = 38.147μV for the MON signals when using factory default settings.

Monitor/V_{CC} Bit Weights

| | | | | | | | | |
|-----|-----------------|-----------------|-----------------|-----------------|-----------------|-----------------|----------------|----------------|
| MSB | 2 ¹⁵ | 2 ¹⁴ | 2 ¹³ | 2 ¹² | 2 ¹¹ | 2 ¹⁰ | 2 ⁹ | 2 ⁸ |
| LSB | 2 ⁷ | 2 ⁶ | 2 ⁵ | 2 ⁴ | 2 ³ | 2 ² | 2 ¹ | 2 ⁰ |

V_{CC} Conversion Examples

| MSB (BIN) | LSB (BIN) | VOLTAGE (V) |
|-----------|-----------|-------------|
| 10000000 | 10000000 | 3.29 |
| 11000000 | 11111000 | 4.94 |

Table 3. Look-up Table Address for Corresponding Temperature Values

| TEMPERATURE (°C) | CORRESPONDING LOOK-UP TABLE ADDRESS |
|------------------|-------------------------------------|
| <-40 | 80h |
| -40 | 80h |
| -38 | 81h |
| -36 | 82h |
| -34 | 83h |
| — | — |
| +98 | C5h |
| +100 | C6h |
| +102 | C7h |
| >+102 | C7h |

Monitor Conversion Example

| MSB (BIN) | LSB (BIN) | VOLTAGE (V) |
|-----------|-----------|-------------|
| 11000000 | 00000000 | 1.875 |
| 10000000 | 10000000 | 1.255 |

To calculate V_{CC}, convert the unsigned 16-bit value to decimal and multiply by 100μV.

To calculate MON1, MON2, or MON3, convert the unsigned 16-bit value to decimal and multiply by 38.147μV.

To calculate the temperature, treat the two's complement value binary number as an unsigned binary number, then convert to decimal and divide by 256. If the result is greater than or equal to 128, subtract 256 from the result.

Temperature: high byte: -128°C to +127°C signed; low byte: 1/256°C.

Temperature Bit Weights

| | | | | | | | |
|-----------------|-----------------|-----------------|-----------------|-----------------|-----------------|-----------------|-----------------|
| S | 2 ⁶ | 2 ⁵ | 2 ⁴ | 2 ³ | 2 ² | 2 ¹ | 2 ⁰ |
| 2 ⁻¹ | 2 ⁻² | 2 ⁻³ | 2 ⁻⁴ | 2 ⁻⁵ | 2 ⁻⁶ | 2 ⁻⁷ | 2 ⁻⁸ |

Temperature Conversion Examples

| MSB (BIN) | LSB (BIN) | TEMPERATURE (°C) |
|-----------|-----------|------------------|
| 01000000 | 00000000 | 64 |
| 01000000 | 00001111 | 64.059 |
| 01011111 | 00000000 | 95 |
| 11110110 | 00000000 | -10 |
| 11011000 | 00000000 | -40 |

Dual, Temperature-Controlled Resistors with Internally Calibrated Monitors

Table 4. ADEN Address Configuration

| ADEN (ADDRESS ENABLE) | NO. OF SEPARATE DEVICE ADDRESSES | ADDITIONAL INFORMATION |
|-----------------------|----------------------------------|------------------------|
| 0 | 2 | See Figure 2 |
| 1 | 1 (Main Device only) | See Figure 3 |

Table 5. ADEN and ADFIX Bits

| ADEN | ADFIX | AUXILIARY ADDRESS | MAIN ADDRESS |
|------|-------|-------------------|------------------------|
| 0 | 0 | A0h | A2h |
| 0 | 1 | A0h | EEPROM (Table 01, 8Ch) |
| 1 | 0 | N/A | A2h |
| 1 | 1 | N/A | EEPROM (Table 01, 8Ch) |

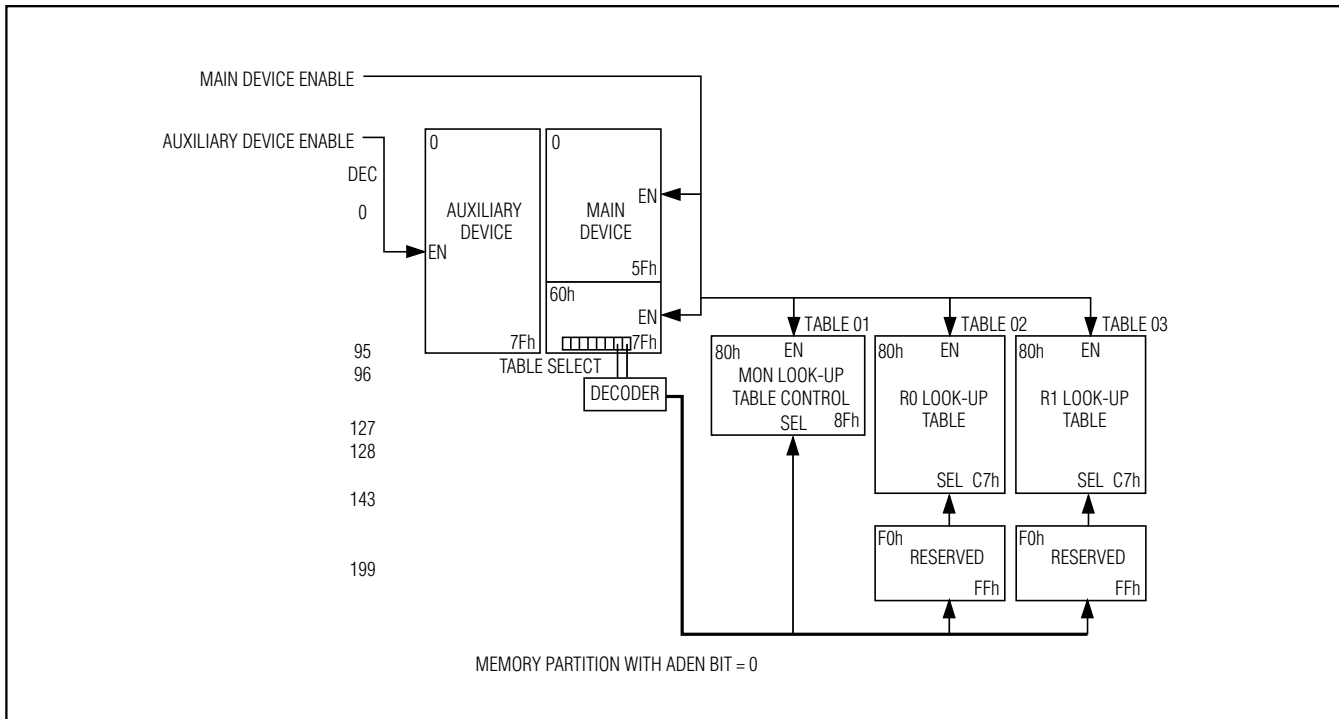

Figure 2. Memory Organization, ADEN = 0

Variable Resistors

The value of each variable resistor is determined by a temperature-addressed look-up table, which can assign a unique value (00h to FFh) to each resistor for every 2°C increment over the -40°C to +102°C range (see Table 3). See the *Temperature Conversion* section for more information.

The variable resistors can also be used in manual mode. If the TEN bit equals 0, the resistors are in manual mode and the temperature indexing is disabled. The user sets the resistors in manual mode by writing to addresses 82h and 83h in Table 01 to control resistors 0 and 1, respectively.

Memory Description

Main and auxiliary memories can be accessed by two separate device addresses. The Main Device address is A2h (or value in Table 01 byte 8Ch, when ADFIX = 1) and the Auxiliary Device address is A0h. A user option is provided to respond to one or two device addresses. This feature can be used to save component count in SFF applications (Main Device address can be used) or other applications where both GBIC (Auxiliary Device address can be used) and monitoring functions are implemented and two device addresses are needed. The memory blocks are enabled with the corresponding device address. Memory space from 80h and

Dual, Temperature-Controlled Resistors with Internally Calibrated Monitors

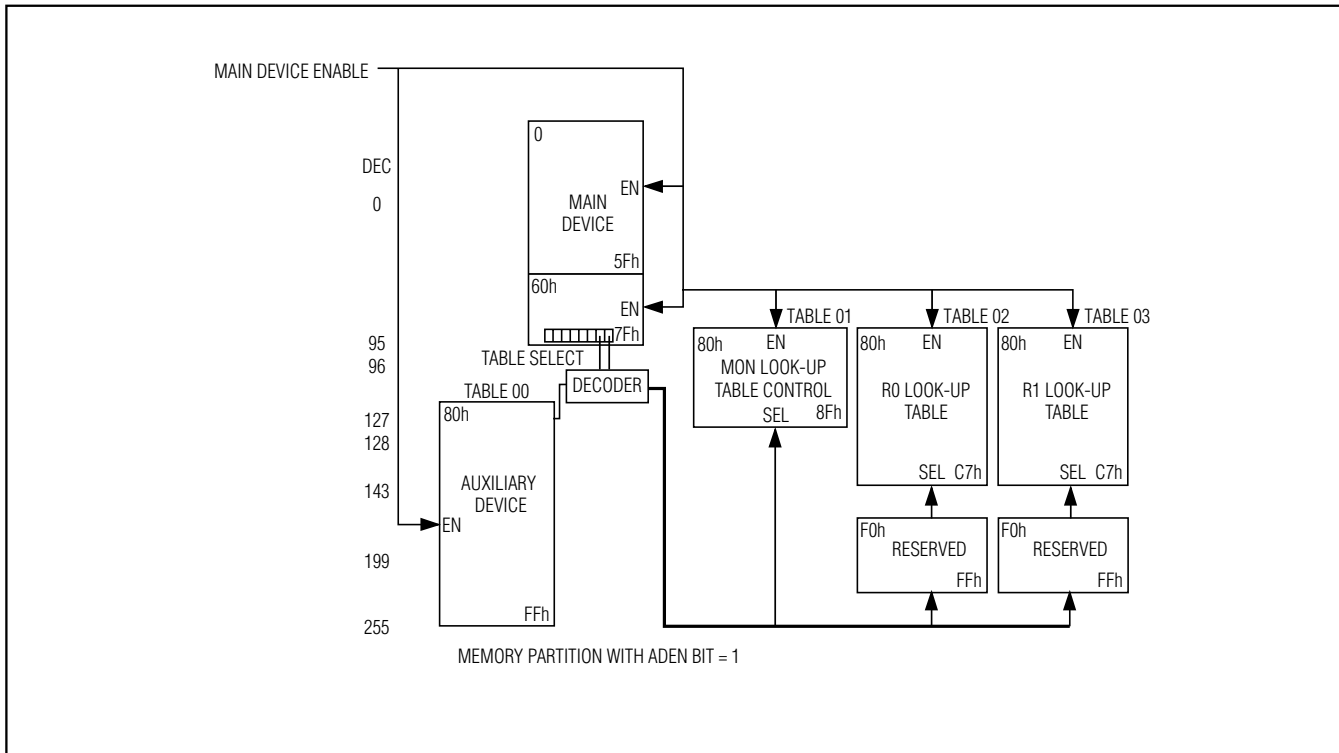

Figure 3. Memory Organization, ADEN = 1

above is accessible only through the Main Device address. This memory is organized as three tables. The desired table can be selected by the contents of memory location 7Fh, Main Device. The Auxiliary Device address has no access to the tables, but the Auxiliary Device address can be mapped into the Main Device's memory space as a fourth table. Device addresses are programmable with two control bits in EEPROM.

Table 6. Main Device

| WPEN | MPEN | PROTECT MAIN |
|------|------|--------------|
| 0 | X | No |
| X | 0 | No |
| 1 | 1 | Yes |

Table 7. Auxiliary Device

| APEN | WPEN | PROTECT AUXILIARY |
|------|------|-------------------|
| 0 | X | No |
| 1 | X | Yes |

ADEN configures memory access to respond to different device addresses (see Tables 4 and 5).

The default device address for EEPROM-generated addresses is A2h.

If the ADEN bit is 1, additional 128 bytes of EEPROM are accessible through the Main Device, selected as Table 00 (see Figure 3). In this configuration, the Auxiliary Device is not accessible. APEN controls the protection of Table 00 regardless of ADEN's setting.

ADFIX (address fixed) determines whether the Main Device address is determined by an EEPROM byte (Table 01, byte 8Ch, when ADFIX = 1). There can be up to 128 devices sharing a common 2-wire bus, with each device having its own unique device address.

Dual, Temperature-Controlled Resistors with Internally Calibrated Monitors

Register Map

A description of the registers is below. The registers are read only (R) or read/write (R/W). The R/W registers are writable only if write protect has not been asserted (see the *Memory Description* section).

Bytes designated as "Reserved" have been set aside for added functionality in future revisions of this device.

Auxiliary Device

| MEMORY LOCATION (hex) | EEPROM/SRAM | R/W | DEFAULT SETTING (hex) | NAME OF LOCATION | FUNCTION |
|-----------------------|-------------|-----|-----------------------|------------------|----------|
| 00 to 7F | EEPROM | R/W | 00 | Standards Data | — |

Main Device

| MEMORY LOCATION (hex) | EEPROM/SRAM | R/W | DEFAULT SETTING (hex) | NAME OF LOCATION | FUNCTION |
|-----------------------|-------------|-----|-----------------------|------------------------|--|
| 00 to 01 | EEPROM | R/W | 00 | TMPlimhi (MSB to LSB) | Contains upper limit settings for temperature. If the limit is violated, an alarm flag in Main Device byte 70h is set. |
| 02 to 03 | EEPROM | R/W | 00 | TMPlimlo (MSB to LSB) | Contains lower limit settings for temperature. If the limit is violated, an alarm flag in Main Device byte 70h is set. |
| 04 to 05 | EEPROM | R/W | 00 | TMPwrnhi (MSB to LSB) | Contains upper limit settings for temperature. If the limit is violated, a warning flag in Main Device byte 74h is set. |
| 06 to 07 | EEPROM | R/W | 00 | TMPwrnlo (MSB to LSB) | Contains lower limit settings for temperature. If the limit is violated, a warning flag in Main Device byte 74h is set. |
| 08 to 09 | EEPROM | R/W | 00 | VCClimhi (MSB to LSB) | Contains upper limit settings for V _{CC} . If the limit is violated, an alarm flag in Main Device byte 70h is set. |
| 0A to 0B | EEPROM | R/W | 00 | VCClimlo (MSB to LSB) | Contains lower limit settings for V _{CC} . If the limit is violated, an alarm flag in Main Device byte 70h is set. |
| 0C to 0D | EEPROM | R/W | 00 | VCCwrnhi (MSB to LSB) | Contains upper limit settings for V _{CC} . If the limit is violated, a warning flag in Main Device byte 74h is set. |
| 0E to 0F | EEPROM | R/W | 00 | VCCwrnlo (MSB to LSB) | Contains lower limit settings for V _{CC} . If the limit is violated, a warning flag in Main Device byte 74h is set. |
| 10 to 11 | EEPROM | R/W | 00 | MON1limhi (MSB to LSB) | Contains upper limit settings for MON1. If the limit is violated, an alarm flag in Main Device byte 70h is set. |

Note: SRAM defaults are power-on defaults. EEPROM defaults are factory defaults.

Dual, Temperature-Controlled Resistors with Internally Calibrated Monitors

Main Device (continued)

| MEMORY LOCATION (hex) | EEPROM/ SRAM | R/W | DEFAULT SETTING (hex) | NAME OF LOCATION | FUNCTION |
|-----------------------|--------------|-----|-----------------------|---------------------------------------|--|
| 12 to 13 | EEPROM | R/W | 00 | MON1limlo (MSB to LSB) | Contains lower limit settings for MON1. If the limit is violated, an alarm flag in Main Device byte 70h is set. |
| 14 to 15 | EEPROM | R/W | 00 | MON1wrnhi (MSB to LSB) | Contains upper limit settings for MON1. If the limit is violated, a warning flag in Main Device byte 74h is set. |
| 16 to 17 | EEPROM | R/W | 00 | MON1wrnlo (MSB to LSB) | Contains lower limit settings for MON1. If the limit is violated, a warning flag in Main Device byte 74h is set. |
| 18 to 19 | EEPROM | R/W | 00 | MON2limhi (MSB to LSB) | Contains upper limit settings for MON2. If the limit is violated, an alarm flag in Main Device byte 70h is set. |
| 1A to 1B | EEPROM | R/W | 00 | MON2limlo (MSB to LSB) | Contains lower limit settings for MON2. If the limit is violated, an alarm flag in Main Device byte 70h is set. |
| 1C to 1D | EEPROM | R/W | 00 | MON2wrnhi (MSB to LSB) | Contains upper limit settings for MON2. If the limit is violated, a warning flag in Main Device byte 74h is set. |
| 1E to 1F | EEPROM | R/W | 00 | MON2wrnlo (MSB to LSB) | Contains lower limit settings for MON2. If the limit is violated, a warning flag in Main Device byte 74h is set. |
| 20 to 21 | EEPROM | R/W | 00 | MON3limhi (MSB to LSB) | Contains upper limit settings for MON3. If the limit is violated, an alarm flag in Main Device byte 71h is set. |
| 22 to 23 | EEPROM | R/W | 00 | MON3limlo (MSB to LSB) | Contains lower limit settings for MON3. If the limit is violated, an alarm flag in Main Device byte 71h is set. |
| 24 to 25 | EEPROM | R/W | 00 | MON3wrnhi (MSB to LSB) | Contains upper limit settings for MON3. If the limit is violated, a warning flag in Main Device byte 75h is set. |
| 26 to 27 | EEPROM | R/W | 00 | MON3wrnlo (MSB to LSB) | Contains lower limit settings for MON3. If the limit is violated, a warning flag in Main Device byte 75h is set. |
| 28 to 37 | EEPROM | — | — | Reserved | — |
| 38 to 5F | EEPROM | R/W | — | Memory | — |
| 60 to 61 | SRAM | R | — | Measured TMP (MSB to LSB) | Digitized measured value for temperature. See Table 1. |
| 62 to 63 | SRAM | R | — | Measured V _{CC} (MSB to LSB) | Digitized measured value for V _{CC} . See Table 1. |
| 64 to 65 | SRAM | R | — | Measured MON1 (MSB to LSB) | Digitized measured value for MON1. See Table 1. |
| 66 to 67 | SRAM | R | — | Measured MON2 (MSB to LSB) | Digitized measured value for MON2. See Table 1. |

Dual, Temperature-Controlled Resistors with Internally Calibrated Monitors

Main Device (continued)

| MEMORY LOCATION (hex) | EEPROM/ SRAM | R/W | DEFAULT SETTING (hex) | NAME OF LOCATION | FUNCTION |
|-----------------------|--------------|-----|-----------------------|----------------------------|--|
| 68 to 69 | SRAM | R | — | Measured MON3 (MSB to LSB) | Digitized measured value for MON3. See Table 1. |
| 6A to 6D | SRAM | — | — | Reserved | — |
| 6E | SRAM | — | — | Logic states | — |
| Bit 7 | — | R | X | HIZSTA | Resistor status bit. A high indicates that both resistors are in high-impedance mode. A low indicates that both resistors are operating normally. |
| 6 | — | R/W | 0 | HIZCO | Resistor control bit. Setting this bit high causes both resistors to go into a high-impedance state. |
| 5 | — | — | X | X | — |
| 4 | — | — | X | X | — |
| 3 | — | — | X | X | — |
| 2 | — | R | X | TXF | This status bit is high when OUT1 is high, assuming there is an external pullup resistor on OUT1. |
| 1 | — | R | X | RXL | This status bit is high when OUT2 is high, assuming there is an external pullup resistor on OUT2. |
| 0 | — | R | X | RDYB | This status bit goes high when V _{CC} has fallen below the POA level. |
| 6F | SRAM | — | — | Conversion updates | — |
| Bit 7 | — | R/W | 0 | TAU | This bit goes high after a temperature and address update has occurred for the corresponding measurement in bytes 60h to 61h. This bit can be written to a 0 by the user and monitored to verify that a conversion has occurred. |
| 6 | — | R/W | 0 | V _{CC} U | This bit goes high after a V _{CC} update has occurred for the corresponding measurement in bytes 62h to 63h. This bit can be written to a 0 by the user and monitored to verify that a conversion has occurred. |
| 5 | — | R/W | 0 | MON1U | This bit goes high after a MON1 update has occurred for the corresponding measurement in bytes 64h to 65h. This bit can be written to a 0 by the user and monitored to verify that a conversion has occurred. |

Dual, Temperature-Controlled Resistors with Internally Calibrated Monitors

Main Device (continued)

| MEMORY LOCATION (hex) | EEPROM/ SRAM | R/W | DEFAULT SETTING (hex) | NAME OF LOCATION | FUNCTION |
|-----------------------|--------------|-----|-----------------------|------------------|---|
| 4 | — | R/W | 0 | MON2U | This bit goes high after a MON2 update has occurred for the corresponding measurement in bytes 66h to 67h. This bit can be written to a 0 by the user and monitored to verify that a conversion has occurred. |
| 3 | — | — | 0 | MON3U | This bit goes high after a MON3 update has occurred for the corresponding measurement in bytes 68h to 69h. This bit can be written to a 0 by the user and monitored to verify that a conversion has occurred. |
| 2 | — | — | 0 | — | — |
| 1 | — | — | 0 | — | — |
| 0 | — | — | 0 | — | — |
| 70 | SRAM | R | — | Alarm flags | — |
| Bit 7 | — | — | — | TMPhi | This alarm flag goes high when the upper limit of the temperature setting is violated. |
| 6 | — | — | — | TMPl0 | This alarm flag goes high when the lower limit of the temperature setting is violated. |
| 5 | — | — | — | Vcchi | This alarm flag goes high when the upper limit of the V _{CC} setting is violated. |
| 4 | — | — | — | Vcclo | This alarm flag goes high when the lower limit of the V _{CC} setting is violated. |
| 3 | — | — | — | MON1hi | This alarm flag goes high when the upper limit of the MON1 setting is violated. |
| 2 | — | — | — | MON1lo | This alarm flag goes high when the lower limit of the MON1 setting is violated. |
| 1 | — | — | — | MON2hi | This alarm flag goes high when the upper limit of the MON2 setting is violated. |
| 0 | — | — | — | MON2lo | This alarm flag goes high when the lower limit of the MON2 setting is violated. |
| 71 | SRAM | R | — | Alarm flags | — |
| Bit 7 | — | — | — | MON3hi | This alarm flag goes high when the upper limit of the MON3 setting is violated. |
| 6 | — | — | — | MON3lo | This alarm flag goes high when the lower limit of the MON3 setting is violated. |
| 5 | — | — | — | X | — |
| 4 | — | — | — | X | — |

Dual, Temperature-Controlled Resistors with Internally Calibrated Monitors

DS1859

Main Device (continued)

| MEMORY LOCATION (hex) | EEPROM/ SRAM | R/W | DEFAULT SETTING (hex) | NAME OF LOCATION | FUNCTION |
|-----------------------|--------------|-----|-----------------------|------------------|--|
| 3 | — | — | — | X | — |
| 2 | — | — | — | X | — |
| 1 | — | — | — | X | — |
| 0 | — | — | — | MINT | A mask of all flags located in Table 01 byte 88h determines the value of MINT. MINT is maskable to 0 if no interrupt is desired by setting Table 01 byte 88h to 0. |
| 72 to 73 | SRAM | — | — | Reserved | — |
| 74 | SRAM | R | — | Warning flags | — |
| Bit 7 | — | — | — | TMPhi | This warning flag goes high when the upper limit of the temperature setting is violated. |
| 6 | — | — | — | TMPllo | This warning flag goes high when the lower limit of the temperature setting is violated. |
| 5 | — | — | — | Vcchi | This warning flag goes high when the upper limit of the V _{CC} setting is violated. |
| 4 | — | — | — | Vcclo | This warning flag goes high when the lower limit of the V _{CC} setting is violated. |
| 3 | — | — | — | MON1hi | This warning flag goes high when the upper limit of the MON1 setting is violated. |
| 2 | — | — | — | MON1lo | This warning flag goes high when the lower limit of the MON1 setting is violated. |
| 1 | — | — | — | MON2hi | This warning flag goes high when the upper limit of the MON2 setting is violated. |
| 0 | — | — | — | MON2lo | This warning flag goes high when the lower limit of the MON2 setting is violated. |

Dual, Temperature-Controlled Resistors with Internally Calibrated Monitors

Main Device (continued)

| MEMORY LOCATION (hex) | EEPROM/ SRAM | R/W | DEFAULT SETTING (hex) | NAME OF LOCATION | FUNCTION |
|-----------------------|--------------|-----|-----------------------|-------------------|---|
| 75 | SRAM | R | — | Warning Flags | — |
| Bit 7 | — | — | 0 | MON3hi | This warning flag goes high when the upper limit of the MON3 setting is violated. |
| 6 | — | — | 0 | MON3lo | This warning flag goes high when the lower limit of the MON3 setting is violated. |
| 5 | — | — | 0 | X | — |
| 4 | — | — | 0 | X | — |
| 3 | — | — | 0 | X | — |
| 2 | — | — | 0 | X | — |
| 1 | — | — | 0 | X | — |
| 76 to 7E | SRAM | — | — | Reserved | — |
| 7F | SRAM | R/W | — | Table select | — |
| Bit 7 | — | — | 0 | X | — |
| 6 | — | — | 0 | X | — |
| 5 | — | — | 0 | X | — |
| 4 | — | — | 0 | X | — |
| 3 | — | — | 0 | X | — |
| 2 | — | — | 0 | X | — |
| 1 | — | — | 0 | Table select bits | Set bits = 00 to select Table 00, set bits = 01 to select Table 01, set bits = 10 to select Table 02, set bits = 11 to select Table 03. |
| 0 | — | — | 0 | | |

Dual, Temperature-Controlled Resistors with Internally Calibrated Monitors

Table 01h

| MEMORY LOCATION (hex) | EEPROM/ SRAM | R/W | DEFAULT SETTING (hex) | NAME OF LOCATION | FUNCTION |
|-----------------------|--------------|-----|-----------------------|-------------------|---|
| 80 | SRAM | R/W | | Mode | — |
| Bit 7 | — | — | 0 | X | — |
| 6 | — | — | 0 | X | — |
| 5 | — | — | 0 | X | — |
| 4 | — | — | 0 | X | — |
| 3 | — | — | 0 | X | — |
| 2 | — | — | 0 | X | — |
| 1 | — | — | 1 | TEN | If TEN = 0, the resistors can be controlled manually. The user sets the resistor in manual mode by writing to addresses 82h and 83h in Table 01 to control resistors 0 and 1, respectively. |
| 0 | — | — | 1 | AEN | AEN = 0 is a test mode setting and provides manual control of the temperature index (Table 01, address 81h). |
| 81 | SRAM | R | — | Temperature index | This byte is the temperature-calculated index used to select the address of resistor settings in the look-up tables (Tables 02 and 03, addresses 80h through C7h). |
| 82 | SRAM | R/W | FF | Resistor 0 | Resistor 0 position values from 00h to FFh. |
| 83 | SRAM | R/W | FF | Resistor 1 | Resistor 1 position values from 00h to FFh. |
| 84 to 87 | SRAM | — | — | Reserved | — |
| 88 | EEPROM | R/W | | Interrupt enable | This byte configures a maskable interrupt, determining which event asserts a buffer 1 output (MINT set to 1, see register 89h in Table 01). If any combination of temperature, V _{CC} , MON1, MON2, or MON3 is desired to generate an interrupt, the corresponding bits are set to 1. If interrupt generation is not desired, set all bits to 0. |
| Bit 7 | — | — | 1 | TMP | — |
| 6 | — | — | 1 | V _{CC} | — |
| 5 | — | — | 1 | MON1 | — |
| 4 | — | — | 1 | MON2 | — |
| 3 | — | — | 1 | MON3 | — |
| 2 | — | — | 0 | X | — |
| 1 | — | — | 0 | X | — |
| 0 | — | — | 0 | X | — |
| 89 | EEPROM | R/W | | Configuration | — |
| Bit 7 | — | — | 0 | X | — |
| 6 | — | — | 0 | X | — |

Dual, Temperature-Controlled Resistors with Internally Calibrated Monitors

Table 01h (continued)

| MEMORY LOCATION (hex) | EEPROM/ SRAM | R/W | DEFAULT SETTING (hex) | NAME OF LOCATION | FUNCTION |
|-----------------------|--------------|-----|-----------------------|-------------------|---|
| 5 | — | — | 0 | ADEN | Controls if the device responds to one or two device addresses (see the <i>Memory Description</i> section and Table 5). |
| 4 | — | — | 0 | ADFIX | Controls the means by which Main and Auxiliary Device addresses are set (see the <i>Memory Description</i> section and Table 5). |
| 3 | — | — | 0 | APEN | Controls auxiliary write protect. See the <i>Memory Description</i> section. |
| 2 | — | — | 0 | MPEN | Controls main write protect. See the <i>Memory Description</i> section. |
| 1 | — | — | 0 | INV1 | Configures buffer 1 with $OUT1 = MINT + (INV1 [XOR] IN1)$. |
| 0 | — | — | 0 | INV2 | Configures buffer 2 with $OUT2 = INV2 [XOR] IN2$. |
| 8A to 8B | EEPROM | — | — | Reserved | |
| 8C | EEPROM | R/W | A2 | Device address | Contains Main Device address if the bit ADFIX = 1. If ADFIX = 0, then address A2h is used. |
| 8D | EEPROM | — | — | Reserved | — |
| 8E | EEPROM | R/W | | | Contains bits used to perform right shift operations on the A/D output converter. See the <i>Right Shift A/D Conversion Result</i> section. |
| 7 | — | — | 0 | — | |
| 6 | — | — | 0 | MON1 ₂ | Right Shift Control MSB |
| 5 | — | — | 0 | MON1 ₁ | |
| 4 | — | — | 0 | MON1 ₀ | Right Shift Control LSB |
| 3 | — | — | 0 | — | |
| 2 | — | — | 0 | MON2 ₂ | Right Shift Control MSB |
| 1 | — | — | 0 | MON2 ₁ | |
| 0 | — | — | 0 | MON2 ₀ | Right Shift Control LSB |
| 8F | EEPROM | R/W | | | Contains bits used to perform right shift operations on the A/D output converter. See the <i>Right Shift A/D Conversion Result</i> section. |
| 7 | — | — | 0 | — | |
| 6 | — | — | 0 | MON3 ₂ | Right Shift Control MSB |
| 5 | — | — | 0 | MON3 ₁ | |
| 4 | — | — | 0 | MON3 ₀ | Right Shift Control LSB |
| 3 | — | — | 0 | — | |
| 2 | — | — | 0 | — | |
| 1 | — | — | 0 | — | |
| 0 | — | — | 0 | — | |

Dual, Temperature-Controlled Resistors with Internally Calibrated Monitors

Table 01h (continued)

| MEMORY LOCATION (hex) | EEPROM/SRAM | R/W | DEFAULT SETTING (hex) | NAME OF LOCATION | FUNCTION |
|-----------------------|-------------|-----|-----------------------|----------------------------|---|
| 90 to 91 | EEPROM | — | 0 | Reserved | |
| 92 to 93 | EEPROM | R/W | Factory Programmed | Gain Cal V _{CC} | Gain registers for internal calibration. See the <i>Internal Calibration</i> section. |
| 94 to 95 | EEPROM | R/W | | Gain Cal Mon1 | |
| 96 to 97 | EEPROM | R/W | | Gain Cal Mon2 | |
| 98 to 99 | EEPROM | R/W | | Gain Cal Mon3 | |
| 9A to 9F | EEPROM | — | | Reserved | |
| A0 to A1 | EEPROM | — | | Reserved | |
| A2 to A3 | EEPROM | R/W | | Offset Cal V _{CC} | Offset registers for internal calibration. See the <i>Internal Calibration</i> section. |
| A4 to A5 | EEPROM | R/W | | Offset Cal Mon1 | |
| A6 to A7 | EEPROM | R/W | | Offset Cal Mon2 | |
| A8 to A9 | EEPROM | R/W | | Offset Cal Mon3 | |
| AA to AD | EEPROM | — | | Reserved | |
| AE to AF | EEPROM | R/W | | Offset Cal Tmp | Offset calibration for temperature calibrated at factory. |

Table 02h

| MEMORY LOCATION (hex) | EEPROM/SRAM | R/W | DEFAULT SETTING (hex) | NAME OF LOCATION | FUNCTION |
|-----------------------|-------------|-----|-----------------------|--------------------------|---|
| 80 to C7 | EEPROM | R/W | FF | Resistor 0 Temp LUT | Look-up table for Resistor 0. |
| F0 to F7 | EEPROM | — | — | Reserved | — |
| F8 to FF | EEPROM | R | Factory Programmed | Resistor 0 Cal Constants | Calibration constants for Resistor 0. (See Table 8) |

Table 03h

| MEMORY LOCATION (hex) | EEPROM/SRAM | R/W | DEFAULT SETTING (hex) | NAME OF LOCATION | FUNCTION |
|-----------------------|-------------|-----|-----------------------|--------------------------|---|
| 80 to C7 | EEPROM | R/W | FF | Resistor 1 Temp LUT | Look-up table for Resistor 1. |
| F0 to F7 | EEPROM | — | — | Reserved | — |
| F8 to FF | EEPROM | R | Factory Programmed | Resistor 1 Cal Constants | Calibration constants for Resistor 1. (See Table 8) |

Dual, Temperature-Controlled Resistors with Internally Calibrated Monitors

Programming the Look-up Table (LUT)

The following equation can be used to determine which resistor position setting, 00h to FFh, should be written in the LUT to achieve a given resistance at a specific temperature.

$$\text{pos}(\alpha, R, C) = \frac{R - u \cdot \left[1 + v \cdot (C - 25) + w \cdot (C - 25)^2 \right]}{(x) \cdot \left[1 + y \cdot (C - 25) + z \cdot (C - 25)^2 \right]} - \alpha$$

$\alpha = 3.852357$ for the 20k Ω resistor

$\alpha = 4.5680475$ for the 50k Ω resistor

R = the resistance desired at the output terminal

C = temperature in degrees Celsius

u, v, w, x₁, x₀, y, and z are calculated values found in the corresponding look-up tables. The variable x from the equation above is separated into x₁ (the MSB of x) and x₀ (the LSB of x). Their addresses and LSB values are given below. Resistor 0 variables are found in Table 1, and Resistor 1 variables are found in Table 2.

When shipped from the factory, all other memory locations in the LUTs are programmed to FFh.

Table 8. Calibration Constants

| ADDRESS (Hex) | VARIABLE | LSB |
|---------------|----------------|-----------------|
| F8 | u | 2 ⁰ |
| F9 | v | 20E-6 |
| FA | w | 100E-9 |
| FB | x ₁ | 2 ¹ |
| FC | x ₀ | 2 ⁻⁷ |
| FD | y | 2E-6 (signed) |
| FE | z | 10E-9 |
| FF | Reserved | — |

Internal Calibration

The DS1859 has two methods for scaling an analog input to a digital result. The two methods are gain and offset. Each of the inputs (V_{CC}, MON1, MON2, and MON3) has a unique register for the gain and the offset found in Table 01h, 92h to 99h, and A2h to A9h.

To scale the gain and offset of the converter for a specific input, you must first know the relationship between the analog input and the expected digital result. The input that would produce a digital result of all zeros is the null value (normally this input is GND). The input that would produce a digital result of all ones is the full-scale (FS) value. The FS value is also found by multiplying an all-ones digital answer by the weighted LSB (e.g., since the digital reading is a 16-bit register, let us

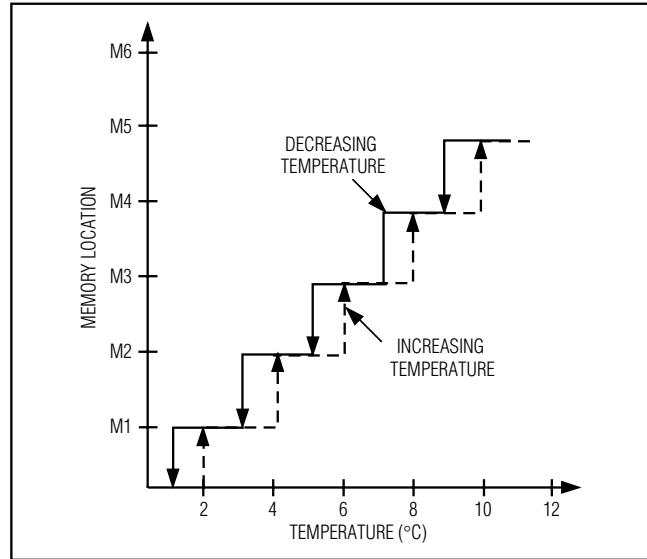

Figure 4. Look-Up Table Hysteresis

assume that the LSB of the lowest weighted bit is 50 μ V, then the FS value is 65,535 x 50 μ V = 3.27675V).

A binary search is used to scale the gain of the converter. This requires forcing two known voltages to the input pin. It is preferred that one of the forced voltages is the null input and the other is 90% of FS. Since the LSB of the least significant bit in the digital reading register is known, the expected digital results are also known for both inputs (null/LSB = CNT1 and 90%FS/LSB = CNT2).

The user might not directly force a voltage on the input. Instead they have a circuit that transforms light, frequency, power, or current to a voltage that is the input to the DS1859. In this situation, the user does not need to know the relationship of voltage to expected digital result but instead knows the relationship of light, frequency, power, or current to the expected digital result.

Dual, Temperature-Controlled Resistors with Internally Calibrated Monitors

An explanation of the binary search used to scale the gain is best served with the following example pseudo-code:

```

/* Assume that the Null input is 0.5V. */
/* In addition, the requirement for LSB is 50µV. */
    FS = 65535 x 50E-6;          /* 3.27675 */
    CNT1 = 0.5 / 50E-6;         /* 10000 */
    CNT2 = 0.90 x FS / 50E-6;   /* 58981.5 */
/* Thus the null input 0.5V and the 90% of FS input is
2.949075V. */
    Set the trim-offset-register to zero;
    Set Right-Shift register to zero (typically zero.
See Right-Shifting section);
    gain_result = 0h;
    Clamp = FFF8h/2^(Right_Shift_Register);
    For n = 15 down to 0
    begin
        gain_result = gain_result + 2^n;
        Force the 90% FS input (2.949075V);
        Meas2 = read the digital result from
the part;
    If Meas2 >= Clamp then
        gain_result = gain_result - 2^n;
    Else
        Force the null input (0.5V);
        Meas1 = read the digital result from
the part;
        if (Meas2 - Meas1) > (CNT2 -
CNT1) then
            gain_result = gain_result - 2^n;
    end;
    Set the gain register to gain_result;

```

The gain register is now set and the resolution of the conversion will best match the expected LSB. The next step is to calibrate the offset of the DS1859. With the correct gain value written to the gain register, again force the null input to the pin. Read the digital result from the part (Meas1). The offset value is equal to the negative value of Meas1.

$$\text{Offset_Register} = \left[4000h - \frac{\text{Meas1}}{2} \right] \text{XOR} [4000h]$$

The calculated offset is now written to the DS1859 and the gain and offset scaling is now complete.

Right-Shifting A/D Conversion Result (Scalable Dynamic Ranging)

The right-shifting method is used to regain some of the lost ADC range of a calibrated system. If a system is calibrated such that the maximum expected input results in a digital output value of less than 7FFFh (1/2 FS), then it is a candidate for using the right-shifting method.

If the maximum desired digital output is less than 7FFFh, then the calibrated system is using less than 1/2 of the ADC's range. Similarly, if the maximum desired digital output is less than 1FFFh, then the calibrated system is only using 1/8 of the ADC's range. For example, if using a zero for the right-shift during internal calibration and the maximum expected input results in a maximum digital output less than 1FFCh, only 1/8 of the ADC's range is used. If left like this, the three MS bits of the ADC will never be used. In this example, a value of 3 for the right-shifting will maximize the ADC range. No resolution is lost since this is a 12-bit converter that is left justified. The value can be right-shifted four times without losing resolution. Table 9 shows when the right-shifting method can be used.

Table 9. Right Shifting

| OUTPUT RANGE USED WITH ZERO RIGHT-SHIFTS | NUMBER OF RIGHT-SHIFTS NEEDED |
|--|-------------------------------|
| 0h .. FFFFh | 0 |
| 0h .. 7FFFh | 1 |
| 0h .. 3FFFh | 2 |
| 0h .. 1FFFh | 3 |
| 0h .. 0FFFh | 4 |

Memory Protection

Memory access from either device address can be either read/write or read only. Write protection is accomplished by a combination of control bits in EEPROM (APEN and MPEN in configuration register 89h) and a write-protect enable (WPEN) pin. Since the WPEN pin is often not accessible from outside the module, this scheme effectively allows the module to be locked by the manufacturer to prevent accidental writes by the end user.

Separate write protection is provided for the Auxiliary and Main Device address through distinct bits APEN and MPEN. APEN and MPEN are bits from configuration register 89h, Table 01. Due to the location, the APEN and MPEN bits can only be written through the

Dual, Temperature-Controlled Resistors with Internally Calibrated Monitors

Main Device address. The control of write privileges through the Auxiliary Device address depends on the value of APEN. Care should be taken with the setting of MPEN, once set to a 1, assuming WPEN is high. Access through the Main Device is thereafter denied unless WPEN is taken to a low level. By this means, inadvertent end-user write access can be denied.

Main Device address space 60h to 7Fh is SRAM and is not write protected by APEN, MPEN, or WPEN. For example, the user may reset flags set by the device. Note that in single device mode (ADEN bit = 1), APEN determines the protection level of Table 00, independent of WPEN.

The write-protect operation, for both Main and Auxiliary Devices, is summarized in Tables 6 and 7.

Temperature Conversion

The direct-to-digital temperature sensor measures temperature through the use of an on-chip temperature measurement technique with an operating range from -40°C to $+102^{\circ}\text{C}$. Temperature conversions are initiated upon power-up, and the most recent conversion is stored in memory locations 60h and 61h of the Main Device, which are updated every t_{frame} . Temperature conversions do not occur during an active read or write to memory.

The value of each resistor is determined by the temperature-addressed look-up table. The look-up table assigns a unique value to each resistor for every 2°C increment with a 1°C hysteresis at a temperature transition over the operating temperature range (see Figure 4).

Power-Up and Low-Voltage Operation

During power-up, the device is inactive until V_{CC} exceeds the digital power-on-reset voltage (POD). At this voltage, the digital circuitry, which includes the 2-wire interface, becomes functional. However, EEPROM-backed registers/settings cannot be internally read (recalled into shadow SRAM) until V_{CC} exceeds the analog power-on-reset voltage (POA), at which time the remainder of the device becomes fully functional. Once V_{CC} exceeds POA, the RDYB bit in byte 6Eh of the Main Device memory is timed to go from a 1 to a 0 and indicates when analog-to-digital conversions begin. If V_{CC} ever dips below POA, the RDYB bit reads as a 1 again. Once a device exceeds POA and the EEPROM is recalled, the values remain active (recalled) until V_{CC} falls below POD.

For 2-wire device addresses sourced from EEPROM (ADFIX = 1), the device address defaults to A2h until V_{CC} exceeds POA and the EEPROM values are recalled. The Auxiliary Device (A0h) is always available within this volt-

age window (between POD and the EEPROM recall) regardless of the programmed state of ADEN.

Furthermore, as the device powers up, the V_{CClo} alarm flag (bit 4 of 70h in Main Device) defaults to a 1 until the first V_{CC} analog-to-digital conversion occurs and sets or clears the flag accordingly.

2-Wire Operation

Clock and Data Transitions: The SDA pin is normally pulled high with an external resistor or device. Data on the SDA pin may only change during SCL-low time periods. Data changes during SCL-high periods will indicate a START or STOP condition depending on the conditions discussed below. See the timing diagrams in Figures 5 and 6 for further details.

START Condition: A high-to-low transition of SDA with SCL high is a START condition that must precede any other command. See the timing diagrams in Figures 5 and 6 for further details.

STOP Condition: A low-to-high transition of SDA with SCL high is a STOP condition. After a read or write sequence, the stop command places the DS1859 into a low-power mode. See the timing diagrams in Figures 5 and 6 for further details.

Acknowledge: All address and data bytes are transmitted through a serial protocol. The DS1859 pulls the SDA line low during the ninth clock pulse to acknowledge that it has received each word.

Standby Mode: The DS1859 features a low-power mode that is automatically enabled after power-on, after a STOP command, and after the completion of all internal operations.

Device Addressing: The DS1859 must receive an 8-bit device address following a START condition to enable a specific device for a read or write operation. The address is clocked into this part MSB to LSB. The address byte consists of either A2h or the value in Table 01 8Ch for the Main Device or A0h for the Auxiliary Device, then the R/W bit. This byte must match the address programmed into Table 01 8Ch or A0h (for the Auxiliary Device). If a device address match occurs, this part will output a zero for one clock cycle as an acknowledge and the corresponding block of memory is enabled (see the *Memory Organization* section). If the R/W bit is high, a read operation is initiated. If the R/W is low, a write operation is initiated (see the *Memory Organization* section). If the address does not match, this part returns to a low-power mode.

Dual, Temperature-Controlled Resistors with Internally Calibrated Monitors

Write Operations

After receiving a matching address byte with the R/W bit set low, if there is no write protect, the device goes into the write mode of operation (see the *Memory Organization* section). The master must transmit an 8-bit EEPROM memory address to the device to define the address where the data is to be written. After the byte has been received, the DS1859 transmits a zero for one clock cycle to acknowledge the address has been received. The master must then transmit an 8-bit data word to be written into this address. The DS1859 again transmits a zero for one clock cycle to acknowledge the receipt of the data. At this point, the master must terminate the write operation with a STOP condition. The DS1859 then enters an internally timed write process t_w to the EEPROM memory. All inputs are disabled during this byte write cycle.

Page Write

The DS1859 is capable of an 8-byte page write. A page is any 8-byte block of memory starting with an address evenly divisible by eight and ending with the starting address plus seven. For example, addresses 00h through 07h constitute one page. Other pages would be addresses 08h through 0Fh, 10h through 17h, 18h through 1Fh, etc.

A page write is initiated the same way as a byte write, but the master does not send a STOP condition after the first byte. Instead, after the slave acknowledges the data byte has been received, the master can send up to seven more bytes using the same nine-clock

sequence. The master must terminate the write cycle with a STOP condition or the data clocked into the DS1859 will not be latched into permanent memory.

The address counter rolls on a page during a write. The counter does not count through the entire address space as during a read. For example, if the starting address is 06h and 4 bytes are written, the first byte goes into address 06h. The second goes into address 07h. The third goes into address 00h (not 08h). The fourth goes into address 01h. If more than 9 bytes or more are written before a STOP condition is sent, the first bytes sent are overwritten. Only the last 8 bytes of data are written to the page.

Acknowledge Polling: Once the internally timed write has started and the DS1859 inputs are disabled, acknowledge polling can be initiated. The process involves transmitting a START condition followed by the device address. The R/W bit signifies the type of operation that is desired. The read or write sequence will only be allowed to proceed if the internal write cycle has completed and the DS1859 responds with a zero.

Read Operations

After receiving a matching address byte with the R/W bit set high, the device goes into the read mode of operation. There are three read operations: current address read, random read, and sequential address read.

Current Address Read

The DS1859 has an internal address register that maintains the address used during the last read or write

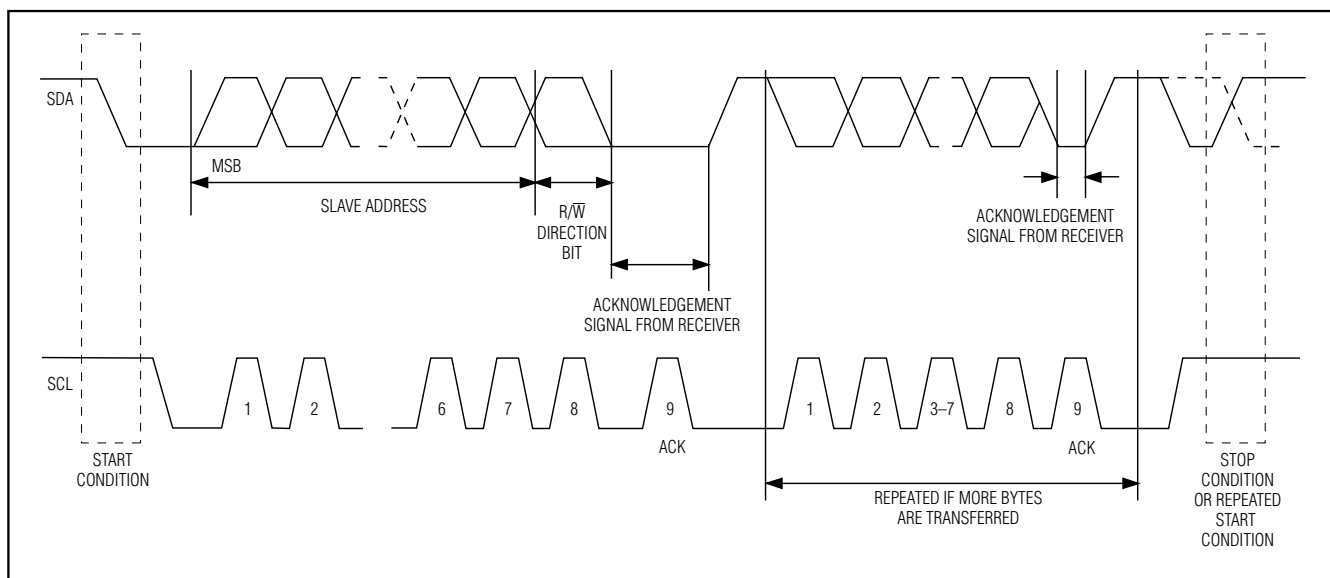

Figure 5. 2-Wire Data Transfer Protocol

Dual, Temperature-Controlled Resistors with Internally Calibrated Monitors

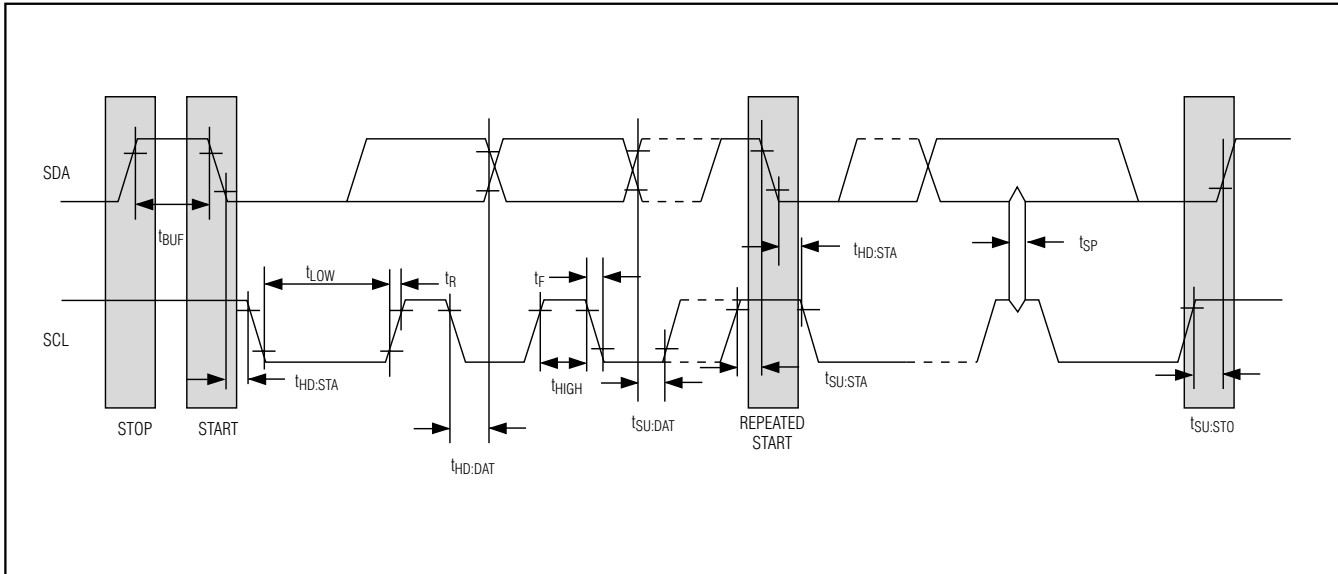

Figure 6. 2-Wire AC Characteristics

operation, incremented by one. This data is maintained as long as V_{CC} is valid. If the most recent address was the last byte in memory, then the register resets to the first address.

Once the device address is clocked in and acknowledged by the DS1859 with the R/\bar{W} bit set to high, the current address data word is clocked out. The master does not respond with a zero, but does generate a STOP condition afterwards.

Single Read

A random read requires a dummy byte write sequence to load in the data byte address. Once the device and data address bytes are clocked in by the master and acknowledged by the DS1859, the master must generate another START condition. The master now initiates a current address read by sending the device address with the R/\bar{W} bit set high. The DS1859 acknowledges the device address and serially clocks out the data byte.

Sequential Address Read

Sequential reads are initiated by either a current address read or a random address read. After the master receives the first data byte, the master responds with an acknowledge. As long as the DS1859 receives this acknowledge after a byte is read, the master can clock out additional data words from the DS1859. After reaching address FFh, it resets to address 00h.

The sequential read operation is terminated when the master initiates a STOP condition. The master does not respond with a zero.

The following section provides a detailed description of the 2-wire theory of operation.

2-Wire Serial-Port Operation

The 2-wire serial-port interface supports a bidirectional data transmission protocol with device addressing. A device that sends data on the bus is defined as a transmitter, and a device that receives data as a receiver. The device that controls the message is called a master. The devices that are controlled by the master are slaves. The bus must be controlled by a master device that generates the serial clock (SCL), controls the bus access, and generates the START and STOP conditions. The DS1859 operates as a slave on the 2-wire bus. Connections to the bus are made through the open-drain I/O lines SDA and SCL. The following I/O terminals control the 2-wire serial port: SDA, SCL. Timing diagrams for the 2-wire serial port can be found in Figures 5 and 6. Timing information for the 2-wire serial port is provided in the *AC Electrical Characteristics* table for 2-wire serial communications.

The following bus protocol has been defined:

- ◆ Data transfer may be initiated only when the bus is not busy.
- ◆ During data transfer, the data line must remain stable whenever the clock line is high. Changes in

Dual, Temperature-Controlled Resistors with Internally Calibrated Monitors

the data line while the clock line is high will be interpreted as control signals.

Accordingly, the following bus conditions have been defined:

Bus not busy: Both data and clock lines remain high.

Start data transfer: A change in the state of the data line from high to low while the clock is high defines a START condition.

Stop data transfer: A change in the state of the data line from low to high while the clock line is high defines the STOP condition.

Data valid: The state of the data line represents valid data when, after a START condition, the data line is stable for the duration of the high period of the clock signal. The data on the line can be changed during the low period of the clock signal. There is one clock pulse per bit of data. Figures 5 and 6 detail how data transfer is accomplished on the 2-wire bus. Depending on the state of the R/W bit, two types of data transfer are possible.

Each data transfer is initiated with a START condition and terminated with a STOP condition. The number of data bytes transferred between START and STOP conditions is not limited and is determined by the master device. The information is transferred byte-wise and each receiver acknowledges with a ninth bit.

Within the bus specifications, a standard mode (100kHz clock rate) and a fast mode (400kHz clock rate) are defined. The DS1859 works in both modes.

Acknowledge: Each receiving device, when addressed, is obliged to generate an acknowledge after the byte has been received. The master device must generate an extra clock pulse, which is associated with this acknowledge bit.

A device that acknowledges must pull down the SDA line during the acknowledge clock pulse in such a way that the SDA line is a stable low during the high period of the acknowledge-related clock pulse. Setup and hold times must be taken into account. A master must signal an end of data to the slave by not generating an acknowledge bit on the last byte that has been clocked out of the slave. In this case, the slave must leave the data line high to enable the master to generate the STOP condition.

- 1) **Data transfer from a master transmitter to a slave receiver.** The first byte transmitted by the master is the command/control byte. Next follows a number of data bytes. The slave returns an acknowledge bit after each received byte.
- 2) **Data transfer from a slave transmitter to a master receiver.** The master transmits the first byte

(the command/control byte) to the slave. The slave then returns an acknowledge bit. Next follows a number of data bytes transmitted by the slave to the master. The master returns an acknowledge bit after all received bytes other than the last byte. At the end of the last received byte, a not acknowledge can be returned.

The master device generates all serial clock pulses and the START and STOP conditions. A transfer is ended with a STOP condition or with a repeated START condition. Since a repeated START condition is also the beginning of the next serial transfer, the bus is not released.

The DS1859 can operate in the following three modes:

- 1) **Slave Receiver Mode:** Serial data and clock are received through SDA and SCL, respectively. After each byte is received, an acknowledge bit is transmitted. START and STOP conditions are recognized as the beginning and end of a serial transfer. Address recognition is performed by hardware after the slave (device) address and direction bit have been received.
- 2) **Slave Transmitter Mode:** The first byte is received and handled as in the slave receiver mode. However, in this mode the direction bit indicates that the transfer direction is reversed. Serial data is transmitted on SDA by the DS1859, while the serial clock is input on SCL. START and STOP conditions are recognized as the beginning and end of a serial transfer.
- 3) **Slave Address:** Command/control byte is the first byte received following the START condition from the master device. The command/control byte consists of 4-bit control code. They are used by the master device to select which of eight possible devices on the bus is to be accessed. When reading or writing to the DS1859, the device-select bits must match one of two valid device addresses, 00h or the address registered in Table 01 location 8Ch. The last bit of the command/control byte (R/W) defines the operation to be performed. When set to a '1' a read operation is selected, and when set to a '0' a write operation is selected. The slave address can be set by the EEPROM. Following the START condition, the DS1859 monitors the SDA bus checking the device type identifier being transmitted. Upon receiving the 1010 control code, the appropriate device address bits, and the read/write bit, the slave device outputs an acknowledge signal on the SDA line.

Dual, Temperature-Controlled Resistors with Internally Calibrated Monitors

Ordering Information (continued)

| PART | RESISTANCE | PIN-PACKAGE |
|-----------------|--------------|-------------|
| DS1859B-050+T&R | 50k Ω | 16 CSBGA |
| DS1859B-050/T&R | 50k Ω | 16 CSBGA |
| DS1859E-020 | 20k Ω | 16 TSSOP |
| DS1859E-020+ | 20k Ω | 16 TSSOP |
| DS1859E-020/T&R | 20k Ω | 16 TSSOP |
| DS1859E-020+T&R | 20k Ω | 16 TSSOP |
| DS1859E-050 | 50k Ω | 16 TSSOP |
| DS1859E-050+ | 50k Ω | 16 TSSOP |
| DS1859E-050+T&R | 50k Ω | 16 TSSOP |
| DS1859E-050/T&R | 50k Ω | 16 TSSOP |

+Denotes lead-free package.

T&R denotes tape-and-reel package.

Chip Information

TRANSISTOR COUNT: 47,191

SUBSTRATE CONNECTED TO GROUND

Package Information

For the latest package outline information, go to www.maxim-ic.com/DallasPackInfo.

Maxim cannot assume responsibility for use of any circuitry other than circuitry entirely embodied in a Maxim product. No circuit patent licenses are implied. Maxim reserves the right to change the circuitry and specifications without notice at any time.

28 **Maxim Integrated Products, 120 San Gabriel Drive, Sunnyvale, CA 94086 408-737-7600**

© 2006 Maxim Integrated Products Printed USA **MAXIM** is a registered trademark of Maxim Integrated Products, Inc.

DALLAS SEMICONDUCTOR is a registered trademark of Dallas Semiconductor Corporation.