

Features

- 64 Input by 64 Output Non-Blocking
- Full Broadcast/Multicast Capability
- 1.6Gb/s NRZ Data Bandwidth
- Designed for HDTV, GE, and FC
- TTL-Compatible Control I/O
- Fully Differential Data Path, PECL-Compatible
- On-Chip Input Terminations
- Single 3.3V Supply, 28W Maximum Dissipation
- High Performance 35mm, 440 BGA Package

General Description

The VSC852 is a monolithic 64x64 asynchronous crosspoint switch, designed to carry broadband data streams up to 1.6Gb/s. Typical applications include Gigabit Fibre Channel/Ethernet and HDTV. The non-blocking switch core is programmed through a serial port interface that allows random access programming of each output port. A high degree of signal integrity is maintained throughout the chip via fully differential signal paths.

The crosspoint function is based on a multiplexer tree architecture. Each data output is driven by a 64:1 multiplexer tree that can be programmed to one and only one of its 64 inputs. The signal path is unregistered, so no clock is required for the data inputs. The signal path is asynchronous, so there are no restrictions on the phase, frequency, or signal pattern at each input. (Note: the maximum frequency for any data line is 1.6Gb/s.)

Each output driver is a fully differential switched current driver with on-die back-terminations for maximum signal integrity. Data inputs are terminated on die through 50Ω resistors to an external V_{TT} supply.

The serial port interface uses TTL levels and provides separate pins for data input and output. Core programming can be sequential for each address or multiple program assignments can be queued and issued simultaneously.

VSC852 Block Diagram

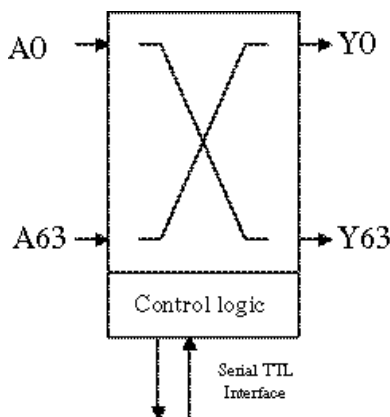

Functional Diagram

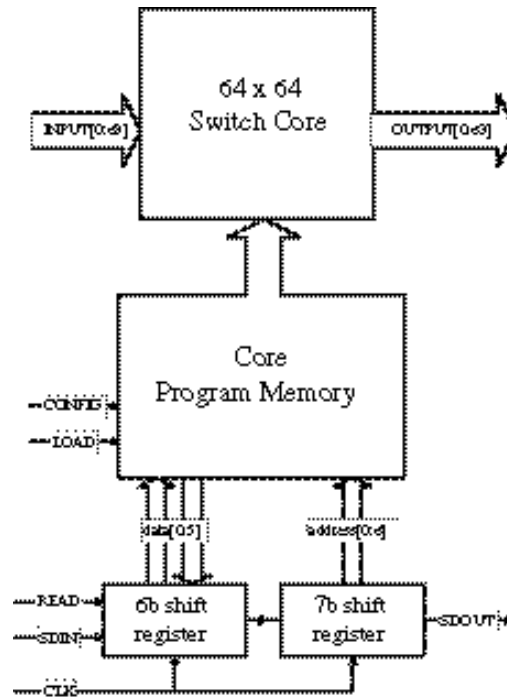

Functional Description

Input/Output Characteristics

All input data must be differential and biased to PECL levels. On-chip terminations are provided, with a nominal impedance of 50Ω. All input termination resistors are tied to V_{TERM} . To minimize power dissipation, the V_{TERM} supply should be biased within $\pm 100\text{mV}$ of the input common-mode voltage (nominally 2.0V). The V_{TERM} supply can be biased below the input common-mode voltage at the expense of increased on-chip power dissipation.

Data outputs are provided through differential current switches with on-chip back-terminations. The drive level of the output circuit is designed to handle external 50Ω termination. Although external termination is not required for correct functional operation, it is strongly recommended to assure proper signal levels and minimize reflections.

Programming Interface

The switch core is programmed through a serial interface circuit that allows sequential reads or writes to the program memory array. The program memory array is buffered to allow multiple programming instructions to be loaded simultaneously with the CONFIG pin.

The program data is composed of two parts: output pin address and input pin address. The output pin address, denoted by A0 through A6, specifies which output channel is to be programmed. Address bit A6 is reserved for future expansion. The input pin address, denoted by D0 through D5, specifies which input port the

switch slice should connect to. The format of the program data is simple binary, where the binary value maps directly to the switch slice position and/or input port number. For example, program data 0000100/010110 would direct output channel Y4 to connect to input channel A22.

To program the switch core, the address and data (13 bits total) for the given output port must be serially clocked into the SDIN input. The LOAD pin must be asserted with the last serial program bit to load the program data into the on-chip program register. The program data will be held in the register until it is either reprogrammed or the chip is powered off. The last step to programming the switch core is to transfer the program data to the registers that control the state of each switch slice. The transfer is completed by asserting the CONFIG pin. The CONFIG pin can be used as a strobe to allow multiple program commands to be implemented simultaneously. The CONFIG pin can also be tied HIGH (always asserted) so the core will reprogram after every LOAD pulse. See Figure 1.

To read the current programming of the switch core, the desired address to query must be clocked into the chip's SDIN port. The format of the program data is the same as for writing. Because of the depth of the on-chip registers, the address bits must be followed by another 6 CLK cycles so the address data is correctly positioned in the internal register. The dummy bits that are clocked in during the last 6 bits of the program data will be overwritten when READ is asserted. As the last dummy bit is clocked in, the READ pin must be asserted to load the on-chip program data into the shift register used for the serial interface logic. See Figure 2.

Figure 1: Write Sequence Timing

Write Cycle Timing

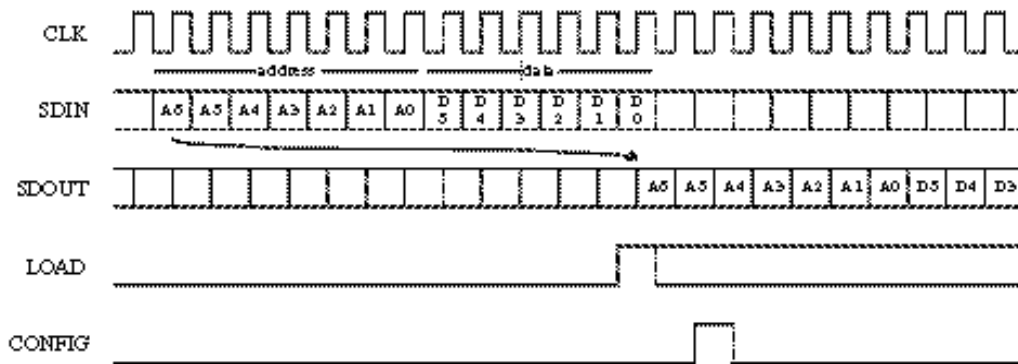
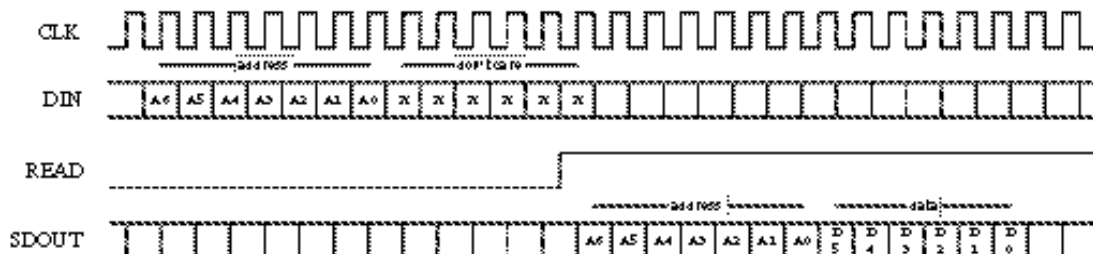

Figure 2: Read Sequence Timing

Read Cycle Timing



DC Characteristics (All characteristics are over the specified operating conditions)

Table 1: Power

Parameter	Description	Min	Typ	Max	Units	Conditions
I_{CC}	V_{CC} supply current	—	—	5400	mA	
I_{CCP}	V_{CCP} supply current	—	—	2600	mA	
I_{TERM}	V_{TERM} supply current	—	—	±512	mA	$V_{IN} = 2.4V$
P_T	Total chip power ($I_{TERM} = 0$)	—	—	-500	μA	$V_{IN} = 0.5V$

NOTE: Specified with outputs terminated with 50Ω to +2.0V.

Table 2: Program Input Levels (TTL)

Parameter	Description	Min	Typ	Max	Units	Conditions
V_{IH}	Input HIGH voltage	2.0	—	3.5	V	—
V_{IL}	Input LOW voltage	0	—	0.8	V	—
I_{IH}	Input HIGH current	—	—	500	μA	$V_{IN} = 2.4V$
I_{IL}	Input LOW current	—	—	-500	μA	$V_{IN} = 0.5V$
V_{OH}	Output HIGH voltage	2.4	---	---	V	$I_{OH} = -2mA$
V_{OL}	Output LOW voltage	---	---	0.4	V	$I_{OL} = 2mA$

Table 3: Data Input Levels (Differential PECL)

Parameter	Description	Min	Typ	Max	Units	Conditions
V_{ID}	Input differential voltage	400	—	1000	mV	single-ended measurement
V_{ICM}	Input common-mode voltage	1.8	—	2.3	V	$V_{TERM} = V_{CC} - 1.3V$

Table 4: Data Output Levels (Differential PECL)

Parameter	Description	Min	Typ	Max	Units	Conditions
V_{OD}	Output differential voltage	600	—	1000	mV	See Note 1
V_{OCM}	Output common-mode voltage	1.8	—	2.3	V	See Note 1

NOTE: (1) $V_{CC} = V_{CCP} = 3.3V$, $V_{EE} = 0V$.

AC Characteristics

Table 5: Data Path

Parameter	Description	Min	Typ	Max	Units
F _{RATE}	Data rate			1.6	Gb/s
T _{SKW}	Channel-to-channel delay skew ⁽¹⁾	-	1	-	ns
t _R , t _F	High-speed input rise/fall times, 20% to 80%			250	ps
t _R , t _F	High-speed output rise/fall times, 20% to 80%	-	-	250	ps
t _{JP}	Output delay jitter, peak-peak ⁽¹⁾			100	ps

NOTE: (1) Tested on sample basis only.

Table 6: Program Interface

Parameter	Description	Min	Typ	Max	Units
T _{PER(CLK)}	Serial clock period	40			ns
T _{PW(CLK)}	Serial clock pulse width	16			ns
T _{SU(SDIN)}	Serial data input setup time	2			ns
T _{HO(SDIN)}	Serial data input hold time	2			ns
T _{SU(READ)}	READ pulse setup time	2			ns
T _{HO(READ)}	READ pulse hold time	2			ns
T _{SU(LOAD)}	LOAD pulse setup time	2			ns
T _{HO(LOAD)}	LOAD pulse hold time	2			ns
T _{PD(SDOUT)}	Serial data output propagation delay ⁽¹⁾			10	ns
T _{D(CONFIG)}	Configuration pulse delay time	3			ns
T _{PW(CONFIG)}	Configuration pulse width	30			ns
T _{PD(CONFIG)}	Configuration delay			5	ns

NOTE: (1) 20pF load.

Figure 3: AC Timing Diagram

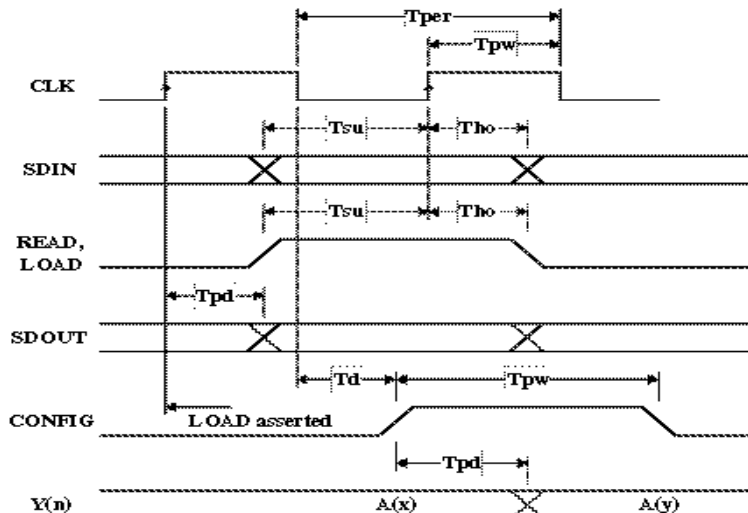

Absolute Maximum Ratings⁽¹⁾

Power Supply Voltage (V_{CC}) Potential to GND.....	-0.5V to +4.0 V
TTL Input Voltage Applied	-0.5V to $V_{CC}+0.5$ V
ECL Input Voltage Applied	-0.5V to $V_{CC}+0.5$ V
Output Current (I_{OUT})	50mA
Case Temperature Under Bias (T_C).....	-55°C to + 125°C
Storage Temperature (T_{STG})	-65°C to + 150°C

NOTE: (1)Caution: Stresses listed under “Absolute Maximum Ratings” may be applied to devices one at a time without causing permanent damage. Functionality at or exceeding the values listed is not implied. Exposure to these values for extended periods may affect device reliability.

Operating Conditions

Supply Voltage (V_{EE})	0V
Supply Voltage (V_{CC}).....	+3.3V ±5%
Supply Voltage (V_{CCP})	+3.3V ±5%
Termination Voltage (V_{TERM})	$V_{CC}-1.3$ V
Case Temperature Operating Range (T).....	0°C to 85°C

ESD Ratings

Proper ESD procedures should be used when handling this product. The VSC852 is rated to the following ESD voltages based on the human body model:

1. All pins are rated at or above 1000V.

Package Pin Descriptions

Figure 4: Functional Pinout Floorplan

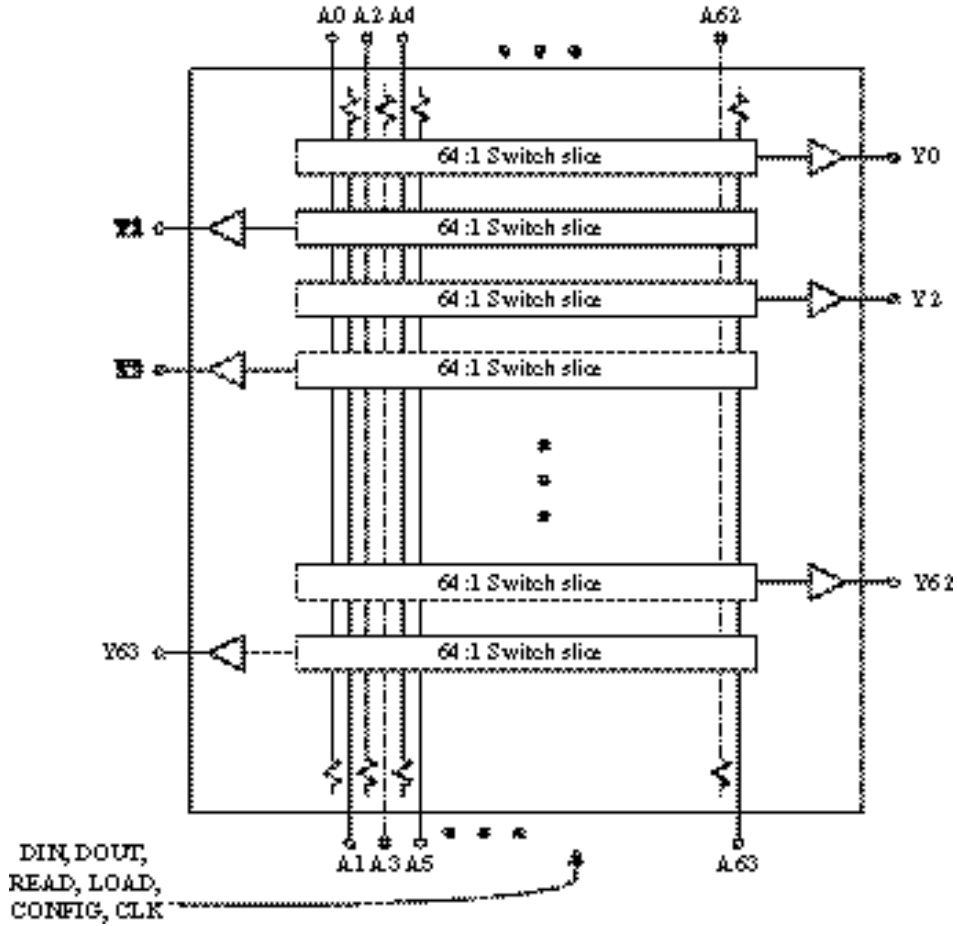

Figure 5: Pinout Diagram

Bottom View

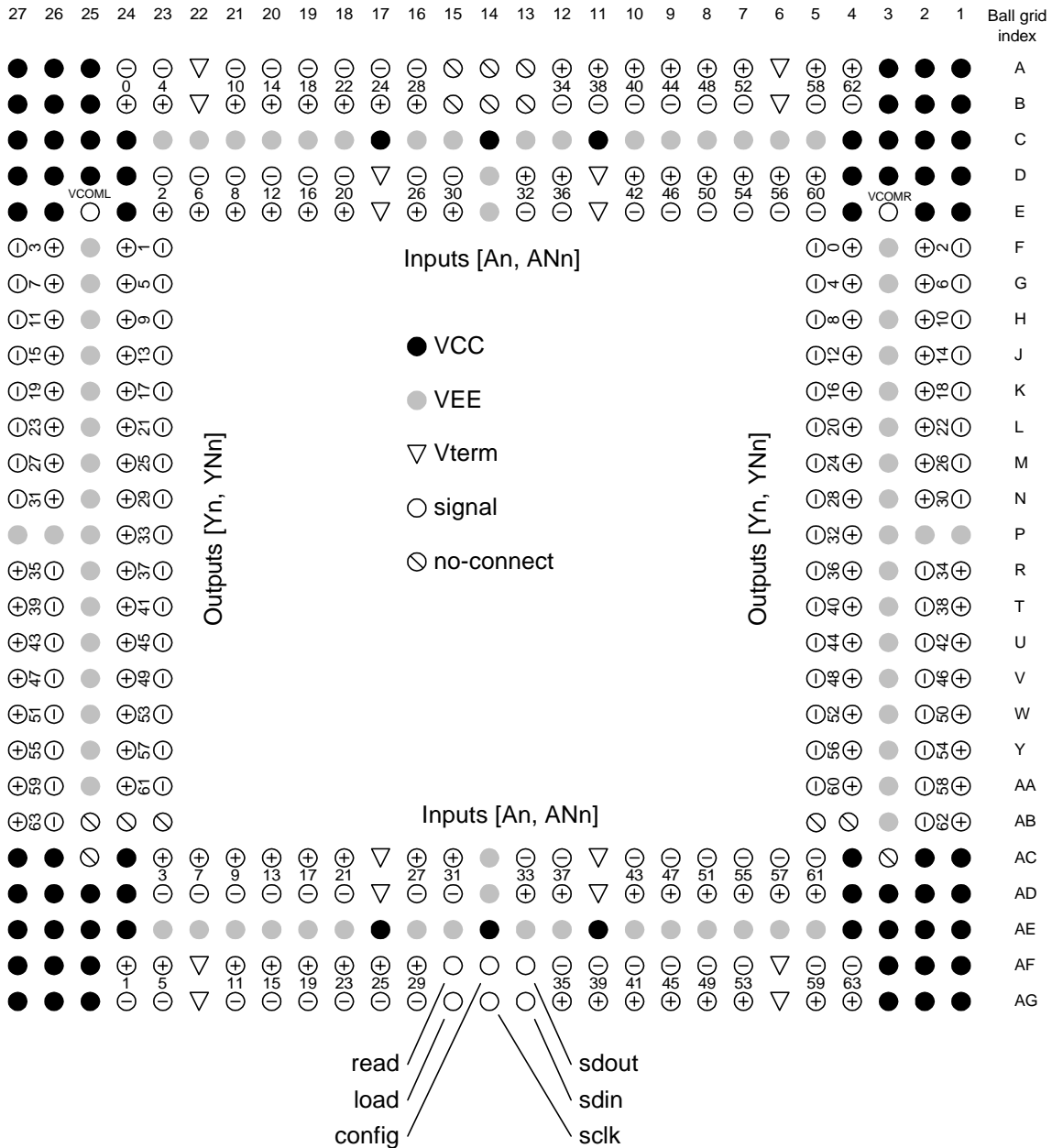

Table 7: Pin Identifications

<i>Signal Name</i>	<i>Pin</i>	<i>Function</i>	<i>Level</i>
<i>High-Speed Data Inputs</i>			
A0, NA0	B24, A24	Data Input	PECL
A1, NA1	AF24, AG24	Data Input	PECL
A2, NA2	E23, D23	Data Input	PECL
A3, NA3	AC23, AD23	Data Input	PECL
A4, NA4	B23, A23	Data Input	PECL
A5, NA5	AF23, AG23	Data Input	PECL
A6, NA6	E22, D22	Data Input	PECL
A7, NA7	AC22, AD22	Data Input	PECL
A8, NA8	E21, D21	Data Input	PECL
A9, NA9	AC21, AD21	Data Input	PECL
A10, NA10	B21, A21	Data Input	PECL
A11, NA11	AF21, AG21	Data Input	PECL
A12, NA12	E20, D20	Data Input	PECL
A13, NA13	AC20, AD20	Data Input	PECL
A14, NA14	B20, A20	Data Input	PECL
A15, NA15	AF20, AG20	Data Input	PECL
A16, NA16	E19, D19	Data Input	PECL
A17, NA17	AC19, AD19	Data Input	PECL
A18, NA18	B19, A19	Data Input	PECL
A19, NA19	AF19, AG19	Data Input	PECL
A20, NA20	E18, D18	Data Input	PECL
A21, NA21	AC18, AD18	Data Input	PECL
A22, NA22	B18, A18	Data Input	PECL
A23, NA23	AF18, AG18	Data Input	PECL
A24, NA24	B17, A17	Data Input	PECL
A25, NA25	AF17, AG17	Data Input	PECL
A26, NA26	E16, D16	Data Input	PECL
A27, NA27	AC16, AD16	Data Input	PECL
A28, NA28	B16, A16	Data Input	PECL
A29, NA29	AF16, AG16	Data Input	PECL
A30, NA30	E15, D15	Data Input	PECL
A31, NA31	AC15, AD15	Data Input	PECL
A32, NA32	D13, E13	Data Input	PECL
A33, NA33	AD13, AC13	Data Input	PECL
A34, NA34	A12, B12	Data Input	PECL
A35, NA35	AG12, AF12	Data Input	PECL

<i>Signal Name</i>	<i>Pin</i>	<i>Function</i>	<i>Level</i>
A36, NA36	D12, E12	Data Input	PECL
A37, NA37	AD12, AC12	Data Input	PECL
A38, NA38	A11, B11	Data Input	PECL
A39, NA39	AG11, AF11	Data Input	PECL
A40, NA40	A10, B10	Data Input	PECL
A41, NA41	AG10, AF10	Data Input	PECL
A42, NA42	D10, E10	Data Input	PECL
A43, NA43	AD10, AC10	Data Input	PECL
A44, NA44	A9, B9	Data Input	PECL
A45, NA45	AG9, AF9	Data Input	PECL
A46, NA46	D9, E9	Data Input	PECL
A47, NA47	AD9, AC9	Data Input	PECL
A48, NA48	A8, B8	Data Input	PECL
A49, NA49	AG8, AF8	Data Input	PECL
A50, NA50	D8, E8	Data Input	PECL
A51, NA51	AD8, AC8	Data Input	PECL
A52, NA52	A7, B7	Data Input	PECL
A53, NA53	AG7, AF7	Data Input	PECL
A54, NA54	D7, E7	Data Input	PECL
A55, NA55	AD7, AC7	Data Input	PECL
A56, NA56	D6, E6	Data Input	PECL
A57, NA57	AD6, AC6	Data Input	PECL
A58, NA58	A5, B5	Data Input	PECL
A59, NA59	AG5, AF5	Data Input	PECL
A60, NA60	D5, E5	Data Input	PECL
A61, NA61	AD5, AC5	Data Input	PECL
A62, NA62	A4, B4	Data Input	PECL
A63, NA63	AG4, AF4	Data Input	PECL
<i>High-Speed Data Outputs</i>			
Y0, YN0	F4, F5	Data Output	PECL
Y1, YN1	F24, F23	Data Output	PECL
Y2, YN2	F2, F1	Data Output	PECL
Y3, YN3	F26, F27	Data Output	PECL
Y4, YN4	G4, G5	Data Output	PECL
Y5, YN5	G24, G23	Data Output	PECL
Y6, YN6	G2, G1	Data Output	PECL
Y7, YN7	G26, G27	Data Output	PECL
Y8, YN8	H4, H5	Data Output	PECL
Y9, YN9	H24, H23	Data Output	PECL

Data Sheet
VSC852

1.6Gb/s 64x64
Crosspoint Switch

<i>Signal Name</i>	<i>Pin</i>	<i>Function</i>	<i>Level</i>
Y10, YN10	H2, H1	Data Output	PECL
Y11, YN11	H26, H27	Data Output	PECL
Y12, YN12	J4, J5	Data Output	PECL
Y13, YN13	J24, J23	Data Output	PECL
Y14, YN14	J2, J1	Data Output	PECL
Y15, YN15	J26, J27	Data Output	PECL
Y16, YN16	K4, K5	Data Output	PECL
Y17, YN17	K24, K23	Data Output	PECL
Y18, YN18	K2, K1	Data Output	PECL
Y19, YN19	K26, K27	Data Output	PECL
Y20, YN20	L4, L5	Data Output	PECL
Y21, YN21	L24, L23	Data Output	PECL
Y22, YN22	L2, L1	Data Output	PECL
Y23, YN23	L26, L27	Data Output	PECL
Y24, YN24	M4, M5	Data Output	PECL
Y25, YN25	M24, M23	Data Output	PECL
Y26, YN26	M2, M1	Data Output	PECL
Y27, YN27	M26, M27	Data Output	PECL
Y28, YN28	N4, N5	Data Output	PECL
Y29, YN29	N24, N23	Data Output	PECL
Y30, YN30	N2, N1	Data Output	PECL
Y31, YN31	N26, N27	Data Output	PECL
Y32, YN32	P4, P5	Data Output	PECL
Y33, YN33	P24, P23	Data Output	PECL
Y34, YN34	R1, R2	Data Output	PECL
Y35, YN35	R27, R26	Data Output	PECL
Y36, YN36	R4, R5	Data Output	PECL
Y37, YN37	R24, R23	Data Output	PECL
Y38, YN38	T1, T2	Data Output	PECL
Y39, YN39	T27, T26	Data Output	PECL
Y40, YN40	T4, T5	Data Output	PECL
Y41, YN41	T24, T23	Data Output	PECL
Y42, YN42	U1, U2	Data Output	PECL
Y43, YN43	U27, U26	Data Output	PECL
Y44, YN44	U4, U5	Data Output	PECL
Y45, YN45	U24, U23	Data Output	PECL
Y46, YN46	V1, V2	Data Output	PECL
Y47, YN47	V27, V26	Data Output	PECL

<i>Signal Name</i>	<i>Pin</i>	<i>Function</i>	<i>Level</i>
Y48, YN48	V4, V5	Data Output	PECL
Y49, YN49	V24, V23	Data Output	PECL
Y50, YN50	W1, W2	Data Output	PECL
Y51, YN51	W27, W26	Data Output	PECL
Y52, YN52	W4, W5	Data Output	PECL
Y53, YN53	W24, W23	Data Output	PECL
Y54, YN54	Y1, Y2	Data Output	PECL
Y55, YN55	Y27, Y26	Data Output	PECL
Y56, YN56	Y4, Y5	Data Output	PECL
Y57, YN57	Y24, Y23	Data Output	PECL
Y58, YN58	AA1, AA2	Data Output	PECL
Y59, YN59	AA27, AA26	Data Output	PECL
Y60, YN60	AA4, AA5	Data Output	PECL
Y61, YN61	AA24, AA23	Data Output	PECL
Y62, YN62	AB1, AB2	Data Output	PECL
Y63, YN63	AB27, AB26	Data Output	PECL
Serial Programming Port			
SDIN	AG13	Serial program data input	TTL
SCLK	AG14	Serial programming clock	TTL
LOAD	AG15	Serial input load strobe	TTL
CONFIG	AF14	Switch configuration strobe	TTL
READ	AF15	Programming read/write control	TTL
SDOUT	AF13	Serial data output	TTL
Power Supplies			
VCC	A1, A2, A25, A26, A27, A3, AC1, AC2, AC24, AC26, AC27, AC4, AD1, AD2, AD24, AD25, AD26, AD27, AD3, AD4, AE1, AE11, AE14, AE17, AE2, AE24, AE25, AE26, AE27, AE3, AE4, AF1, AF2, AF25, AF26, AF27, AF3, AG1, AG2, AG25, AG26, AG27, AG3, B1, B2, B25, B26, B27, B3, C1, C11, C14, C17, C2, C24, C25, C26, C27, C3, C4, D1, D2, D24, D25, D26, D27, D3, D4, E1, E2, E24, E26, E27, E4	Power	+3.3V

Data Sheet
VSC852

1.6Gb/s 64x64
Crosspoint Switch

<i>Signal Name</i>	<i>Pin</i>	<i>Function</i>	<i>Level</i>
VEE	AC14, AD14, AE10, AE12, AE13, AE15, AE16, AE18, AE19, AE20, AE21, AE22, AE23, AE5, AE6, AE7, AE8, AE9, C10, C12, C13, C15, C16, C18, C19, C20, C21, C22, C23, C5, C6, C7, C8, C9, D14, E14, P1, P2, P26, P27	Power	GND
VEEP0	F3	Power for Y0, YN0, Y2, YN2	GND
VEEP1	F25	Power for Y1, YN1, Y3, YN3	GND
VEEP2	G3	Power for Y4, YN4, Y6, YN6	GND
VEEP3	G25	Power for Y5, YN5, Y7, YN7	GND
VEEP4	H3	Power for Y8, YN8, Y10, YN10	GND
VEEP5	H25	Power for Y9, YN9, Y11, YN11	GND
VEEP6	J3	Power for Y12, YN12, Y14, YN14	GND
VEEP7	J25	Power for Y13, YN13, Y15, YN15	GND
VEEP8	K3	Power for Y16, YN16, Y18, YN18	GND
VEEP9	K25	Power for Y17, YN17, Y19, YN19	GND
VEEP10	L3	Power for Y20, YN20, Y22, YN22	GND
VEEP11	L25	Power for Y21, YN21, Y23, YN23	GND
VEEP12	M3	Power for Y24, YN24, Y26, YN26	GND
VEEP13	M25	Power for Y25, YN25, Y27, YN27	GND
VEEP14	N3	Power for Y28, YN28, Y30, YN30	GND
VEEP15	N25	Power for Y29, YN29, Y31, YN31	GND
VEEP16	P3	Power for Y32, YN32, Y34, YN34	GND
VEEP17	P25	Power for Y33, YN33, Y35, YN35	GND
VEEP18	R3	Power for Y36, YN36, Y38, YN38	GND
VEEP19	R25	Power for Y37, YN37, Y39, YN39	GND
VEEP20	T3	Power for Y40, YN40, Y42, YN42	GND
VEEP21	T25	Power for Y41, YN41, Y43, YN43	GND
VEEP22	U3	Power for Y44, YN44, Y46, YN46	GND
VEEP23	U25	Power for Y45, YN45, Y47, YN47	GND
VEEP24	V3	Power for Y48, YN48, Y50, YN50	GND
VEEP25	V25	Power for Y49, YN49, Y51, YN51	GND
VEEP26	W3	Power for Y52, YN52, Y54, YN54	GND
VEEP27	W25	Power for Y53, YN53, Y55, YN55	GND
VEEP28	Y3	Power for Y56, YN56, Y58, YN58	GND
VEEP29	Y25	Power for Y57, YN57, Y59, YN59	GND
VEEP30	AA3	Power for Y60, YN60, Y62, YN62	GND

<i>Signal Name</i>	<i>Pin</i>	<i>Function</i>	<i>Level</i>
VEEP31	AA25	Power for Y61, YN61, Y63, YN63	GND
VTERM0	AC17, AD17, AF22, AG22	Termination supply for A0 - AN28	+2.0V
VTERM1	A22, B22, D17, E17	Termination supply for A1 - AN31	+2.0V
VTERM2	AC11, AD11, AF6, AG6	Termination supply for A34 - NA62	+2.0V
VTERM3	A6, B6, D11, E11	Termination supply for A33 - NA63	+2.0V
Misc			
VCOML	E25	Bias level for Y1 - YN63	ANALOG
VCOMR	E3	Bias level for Y0 - YN63	ANALOG
NC1	AB4	—	No Connect ⁽¹⁾
NC2	AB5	—	No Connect ⁽¹⁾

NOTE: (1) No connect (NC) pins must be left unconnected. Connecting this pin to either the positive or negative power supply rails may cause improper operation or failure of the device or in extreme cases, cause permanent damage to the device.

Package Information

35mm 440 BGA Package Drawing

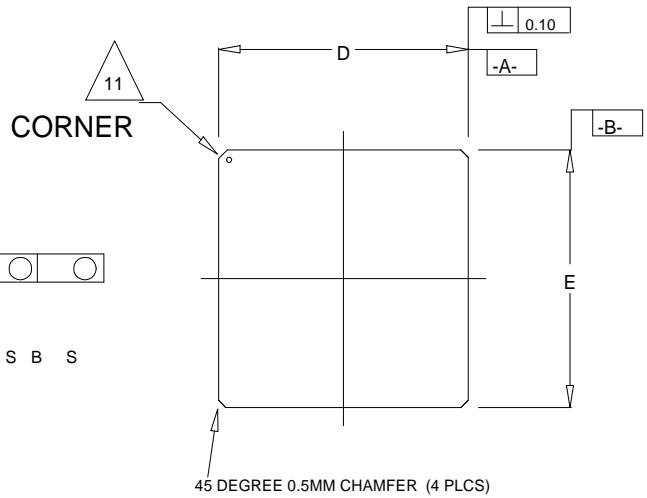
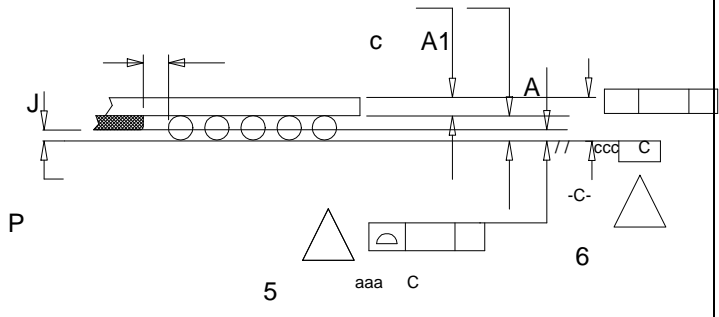
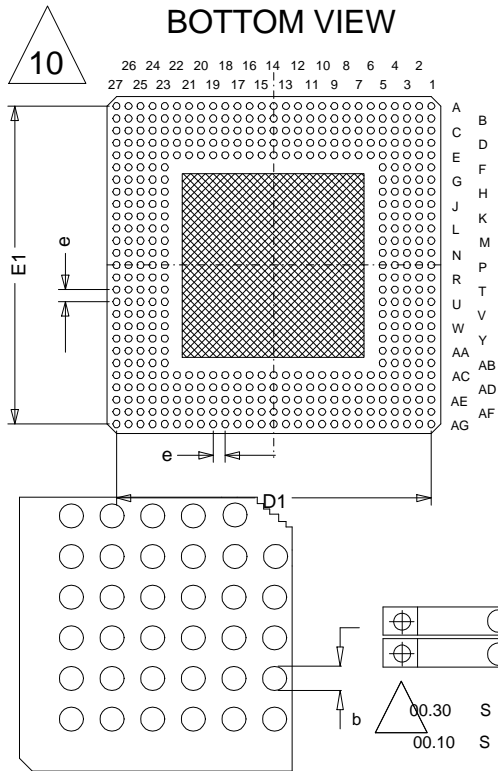

DIMENSIONAL REFERENCES			
REF.	MIN.	NOM.	MAX.
A	1.65	1.80	1.95
A1	0.60	0.65	0.70
D	34.80	35.00	35.20
D1		33.02 (BSC.)	
E	34.80	35.00	35.20
E1		33.02 (BSC.)	
b	0.65	0.75	0.85
c	1.05	1.15	1.25
M		27	
N		440	

aaa		0.15
ccc		0.15
e	1.27 TYP.	
P		0.25
J	0.25	

NOTES:

- ALL DIMENSIONS ARE IN MILLIMETERS.
- "e" REPRESENTS THE BASIC SOLDER BALL GRID PITCH.
- "M" REPRESENTS THE BASIC SOLDER BALL MATRIX SIZE, AND SYMBOL "N" IS THE MAXIMUM ALLOWABLE NUMBER OF BALLS AFTER DEPOPULATING.
- "b" IS MEASURED AT THE MAXIMUM SOLDER BALL DIAMETER PARALLEL TO PRIMARY DATUM -C-.
- DIMENSION "aaa" IS MEASURED PARALLEL TO PRIMARY DATUM -C-.
- PRIMARY DATUM -C- AND SEATING PLANE ARE DEFINED BY THE SPHERICAL CROWNS OF THE SOLDER BALLS.
- PACKAGE SURFACE SHALL BE NICKEL PLATED.
- AFTER SURFACE MOUNT ASSEMBLY, SOLDER BALL WILL HAVE 0.15mm(TYP.) COLLAPSE IN "A" DIMENSION.
- SUBSTRATE MATERIAL BASE IS COPPER.
- BILATERAL TOLERANCE ZONE IS APPLIED TO EACH SIDE OF PACKAGE BODY
- 45 DEG. 0.5mm CHAMFER CORNER AND WHITE DOT FOR PIN 1 IDENTIFICATION
- ENCAPSULANT SIZE MAY VARY WITH DIE SIZE.
- CAVITY DEPTH C1 VARIOUS WITH DIE THICKNESS.

Ordering Information

The order number for this product is formed by a combination of the device number, and package type.

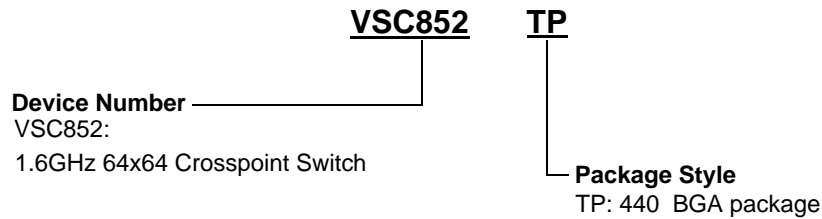

Notice

Vitesse Semiconductor Corporation reserves the right to make changes in its products specifications or other information at any time without prior notice. Therefore the reader is cautioned to confirm that this data sheet is current prior to placing orders. The Company assumes no responsibility for any circuitry described other than circuitry entirely embodied in a Vitesse product.

Warning

Vitesse Semiconductor Corporation's products are not intended for use in life support appliances, devices or systems. Use of a Vitesse product in such applications without written consent is prohibited.