

# Power Inductors

## Model HM72L-0630 series



### Features:

- Operating Temperature Range  $-55^{\circ}\text{C}$  to  $+125^{\circ}\text{C}$
- Ambient Temperature, Maximum  $+85^{\circ}\text{C}$
- Temperature Rise,  $40^{\circ}\text{C}$
- RoHS Compliant



All parts are Pb-free and comply with EU Directive 2011/65/EU (RoHS2)

### Schematic

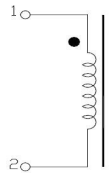

### Specifications @ $25^{\circ}\text{C}$

Part Number	Inductance ( $\mu\text{H} \pm 20\%$ @0A)	DCR (m $\Omega$ ) Typ	DCR (m $\Omega$ ) Max	I <sub>rms</sub> (A)	Isat (A)	Part Number	Inductance ( $\mu\text{H} \pm 20\%$ @0A)	DCR (m $\Omega$ ) Typ.	DCR (m $\Omega$ ) Max	I <sub>rms</sub> (A)	Isat (A)
HM72L-0630R10LFTR	0.10	1.5	1.7	32.5	60.0	HM72L-06301R0LFTR	1.00	9.0	10.0	11.0	22.0
HM72L-0630R15LFTR	0.15	1.9	2.5	26.0	52.0	HM72L-06301R5LFTR	1.50	14.0	15.0	9.0	18.0
HM72L-0630R20LFTR	0.20	2.4	3.0	24.0	41.0	HM72L-06302R2LFTR	2.20	18.0	20.0	8.0	14.0
HM72L-0630R22LFTR	0.22	2.5	2.8	23.0	40.0	HM72L-06303R3LFTR	3.30	28.0	30.0	6.0	13.5
HM72L-0630R33LFTR	0.33	3.5	3.9	20.0	30.0	HM72L-06304R7LFTR	4.70	37.0	40.0	5.5	10.0
HM72L-0630R47LFTR	0.47	4.0	4.2	17.5	26.0	HM72L-06305R6LFTR	5.60	52.0	60.0	4.8	10.0
HM72L-0630R56LFTR	0.56	5.0	5.5	15.5	25.0	HM72L-06306R8LFTR	6.80	54.0	60.0	4.5	8.0
HM72L-0630R68LFTR	0.68	5.0	5.5	15.5	25.0	HM72L-06308R2LFTR	8.20	64.0	68.0	4.0	7.5
HM72L-0630R82LFTR	0.82	6.7	8.0	13.0	24.0	HM72L-0630100LFTR	10.0	102.0	105.0	3.0	7.0

- Notes: (1) Isat is the saturation current at which inductance rolls off approximately 30% from its initial (zero DC)  
 (2) I<sub>rms</sub> is the approximate current at which  $\Delta T = 40^{\circ}\text{C}$   
 (3) Operating Temperature Range  $-55^{\circ}\text{C}$  to  $+125^{\circ}\text{C}$

#### General Note

TT Electronics reserves the right to make changes in product specification without notice or liability. All information is subject to TT Electronics' own data and is considered accurate at time of going to print.

TT Electronics | BI Technologies

A-1445, Jalan Tanjung Api  
 25050 Kuantan Pahang Darul Makmur, Malaysia | Ph: +60 9 565 8888  
[www.ttelectronicsmagnetics.com/customer-service-enquiry](http://www.ttelectronicsmagnetics.com/customer-service-enquiry)

### Electrical Specifications @ 25

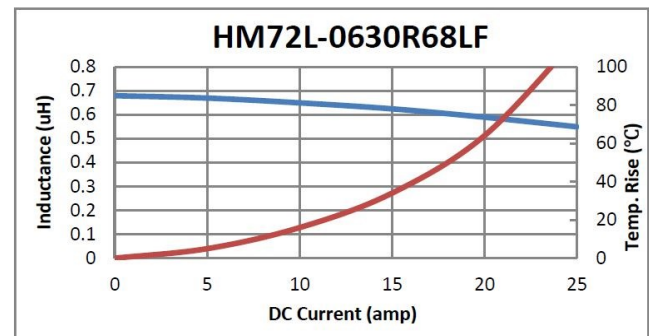
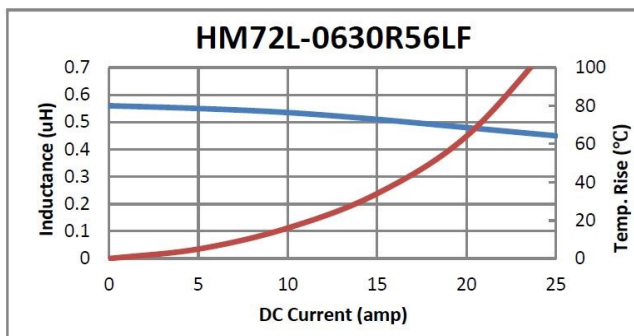
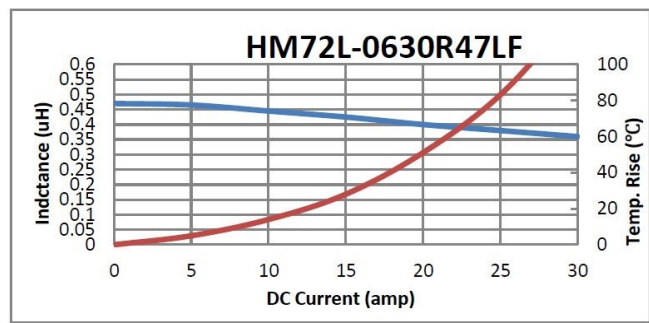
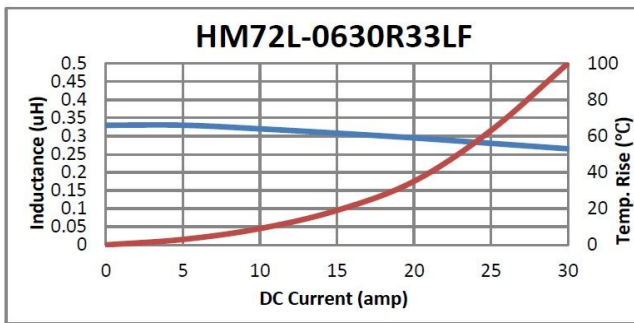
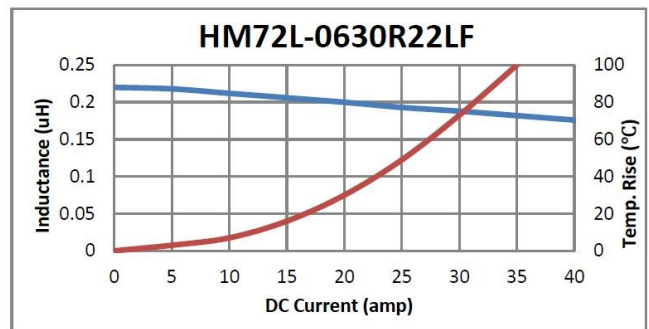
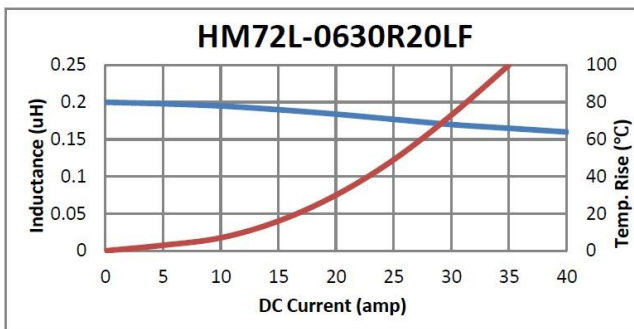
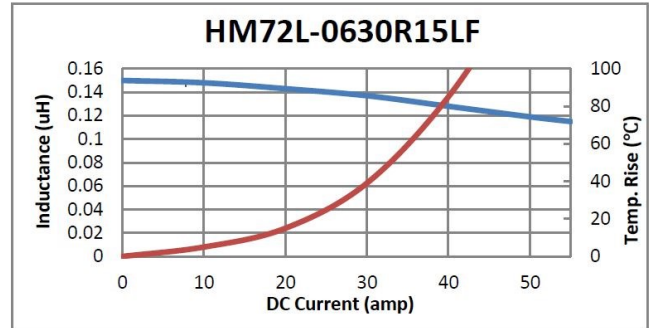
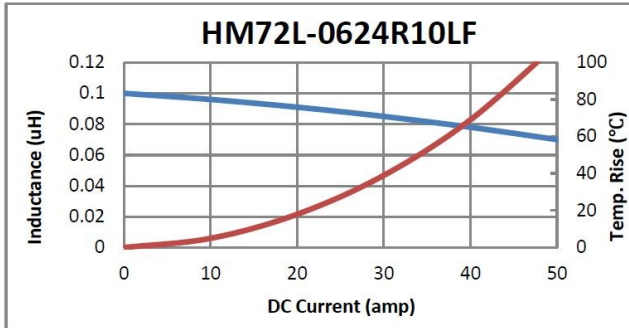

General Note  
 TT Electronics reserves the right to make changes in product specification without notice or liability. All information is subject to TT Electronics' own data and is considered accurate at time of going to print.

TT Electronics | BI Technologies  
 A-1445, Jalan Tanjung Api  
 25050 Kuantan Pahang Darul Makmur, Malaysia | Ph: +60 9 565 8888  
[www.ttelectronicsmagnetics.com/customer-service-enquiry](http://www.ttelectronicsmagnetics.com/customer-service-enquiry)

### Electrical Specifications @ 25

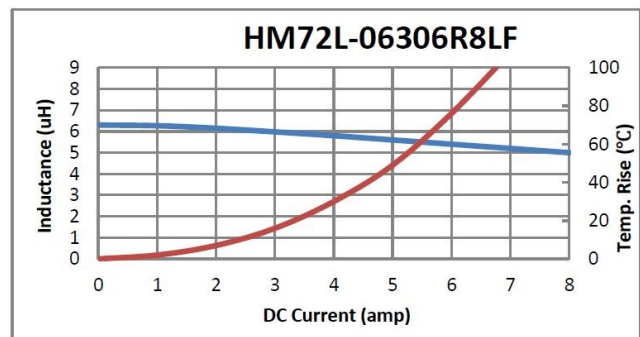
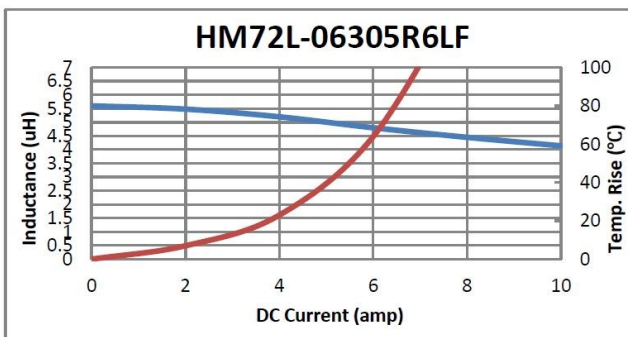
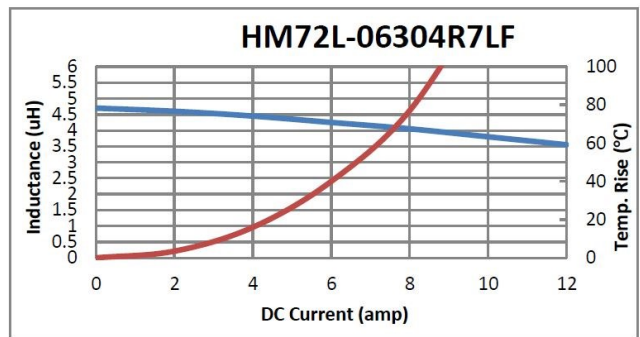
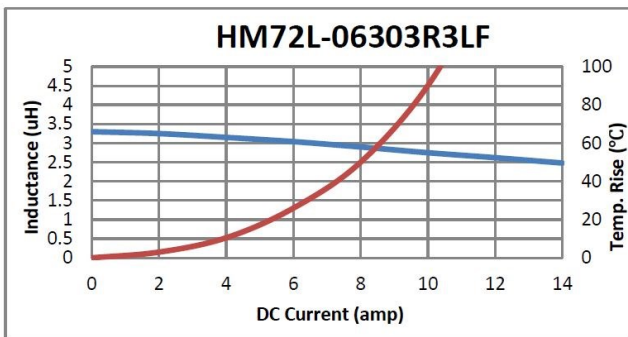
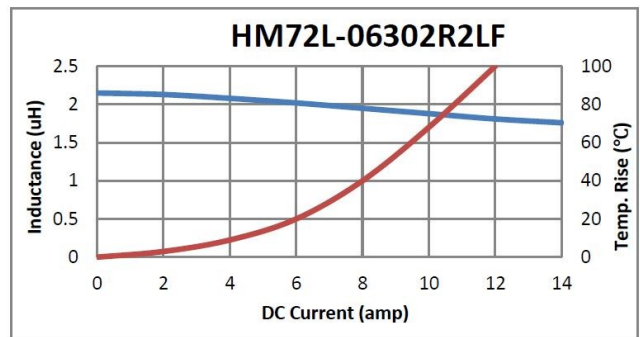
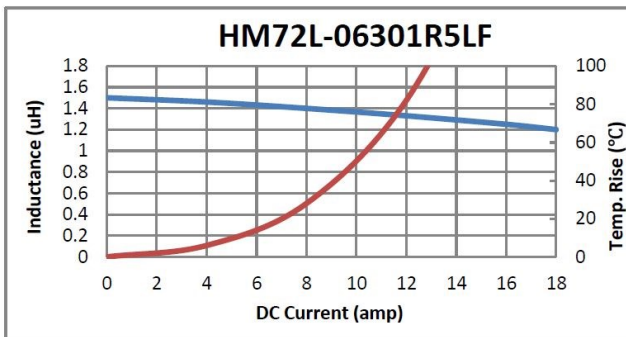
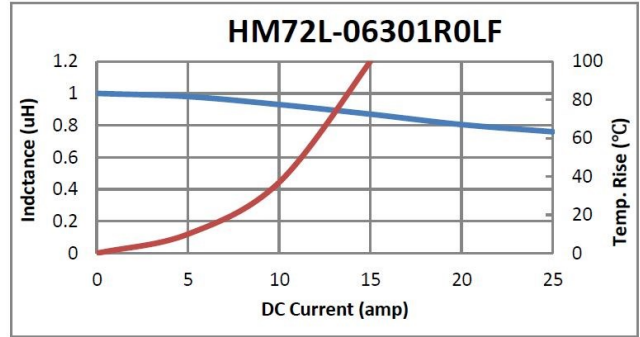
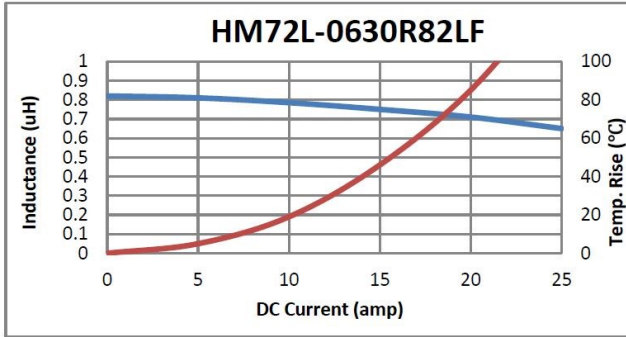

General Note  
 TT Electronics reserves the right to make changes in product specification without notice or liability. All information is subject to TT Electronics' own data and is considered accurate at time of going to print.

TT Electronics | BI Technologies  
 A-1445, Jalan Tanjung Api  
 25050 Kuantan Pahang Darul Makmur, Malaysia | Ph: +60 9 565 8888  
[www.ttelectronicsmagnetics.com/customer-service-enquiry](http://www.ttelectronicsmagnetics.com/customer-service-enquiry)

### Electrical Specifications @ 25

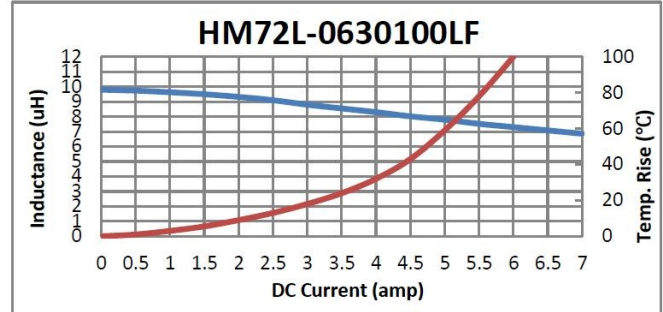
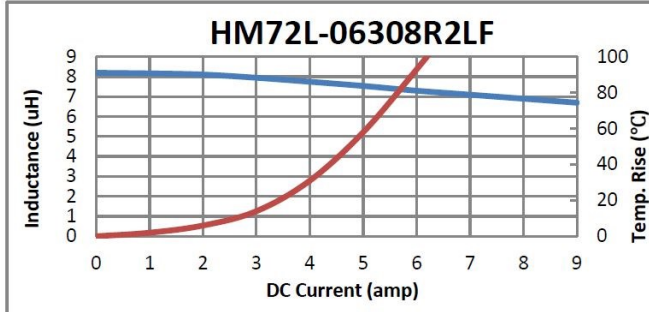

### Outline dimensions (mm)

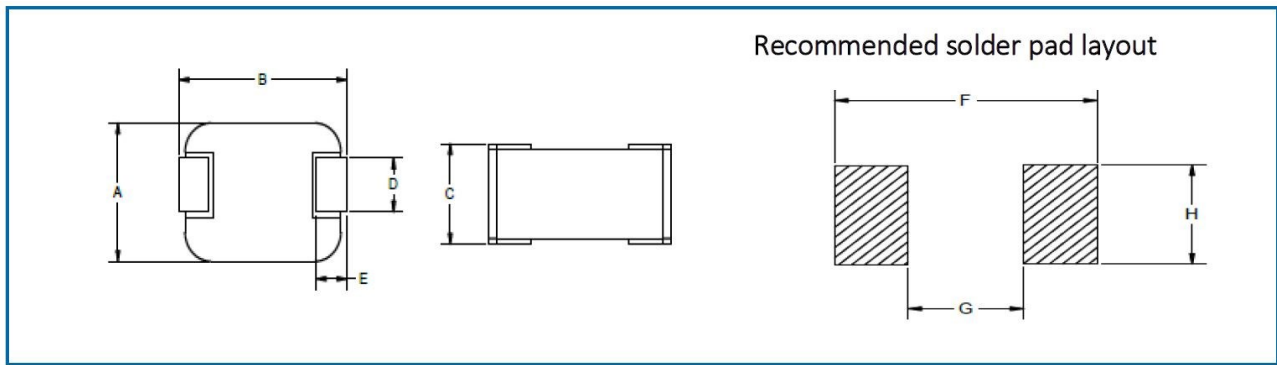

CASE SIZE	A(mm)	B(mm)	C(mm)	D(mm)	E(mm)	F(mm)	G(mm)	H(mm)
0630 series	6.6 ± 0.3	7.1 ± 0.3	3	3.0 ± 0.3	1.6 ± 0.5	7.4	3.7	3.5

**General Note**

TT Electronics reserves the right to make changes in product specification without notice or liability. All information is subject to TT Electronics' own data and is considered accurate at time of going to print.

### Packaging

Standard:	Embossed Tape and Reel			
	Diameter:	All case size	=	13" (330mm)
	Reel:	Case size 0630	=	1,000 units

### Ordering information

HM72L – XXXX XXX LF TR

