

isc P-Channel MOSFET Transistor

IRF4905, IIRF4905

• FEATURES

- Static drain-source on-resistance:
 $R_{DS(on)} \leq 0.02 \Omega$
- Enhancement mode:
- 100% avalanche tested
- Minimum Lot-to-Lot variations for robust device performance and reliable operation

• DESCRIPTION

- Combine with the fast switching speed and ruggedized device design, provide the designer with an extremely efficient and reliable device for use in a wide variety of applications.

• ABSOLUTE MAXIMUM RATINGS ($T_a=25^\circ\text{C}$)

SYMBOL	PARAMETER	VALUE	UNIT
V_{DS}	Drain-Source Voltage	-55	V
V_{GS}	Gate-Source Voltage	± 20	V
I_D	Drain Current-Continuous	-74	A
I_{DM}	Drain Current-Single Pulsed	-260	A
P_D	Total Dissipation @ $T_c=25^\circ\text{C}$	200	W
T_j	Max. Operating Junction Temperature	175	$^\circ\text{C}$
T_{stg}	Storage Temperature	-55~175	$^\circ\text{C}$

• THERMAL CHARACTERISTICS

SYMBOL	PARAMETER	MAX	UNIT
$R_{th(j-c)}$	Channel-to-case thermal resistance	0.75	$^\circ\text{C/W}$
$R_{th(j-a)}$	Channel-to-ambient thermal resistance	62	$^\circ\text{C/W}$

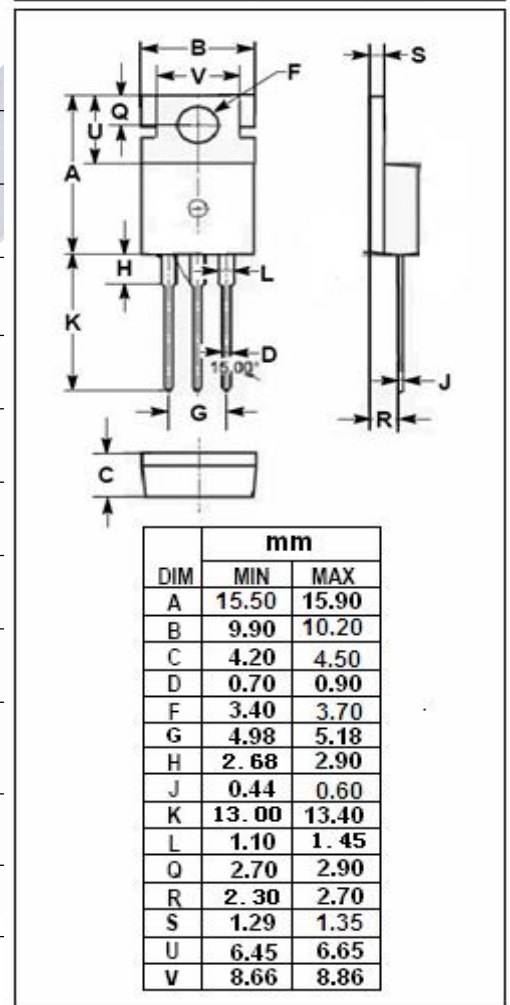
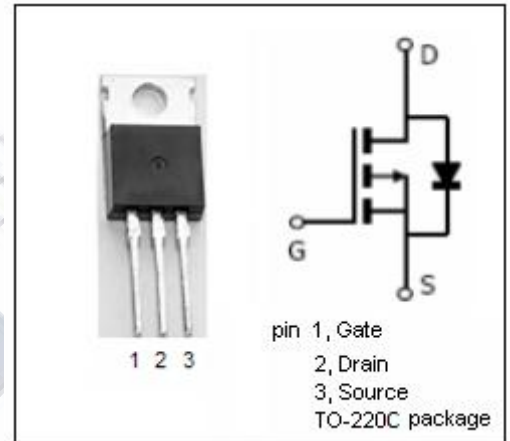

isc P-Channel MOSFET Transistor
IRF4905, IIRF4905
ELECTRICAL CHARACTERISTICS

 T_C=25°C unless otherwise specified

SYMBOL	PARAMETER	CONDITIONS	MIN	TYP	MAX	UNIT
BV _{DSS}	Drain-Source Breakdown Voltage	V _{GS} =0V; I _D = -250 μA	-55			V
V _{GS(th)}	Gate Threshold Voltage	V _{DS} =V _{GS} ; I _D = -250 μA	-2.0		-4.0	V
R _{DS(on)}	Drain-Source On-Resistance	V _{GS} = -10V; I _D = -38A			0.02	Ω
I _{GSS}	Gate-Source Leakage Current	V _{GS} = ±20V			±100	nA
I _{DSS}	Drain-Source Leakage Current	V _{DS} = -55V; V _{GS} = 0V			-25	μA
V _{SD}	Diode forward voltage	I _S = -38A; V _{GS} = 0V			-1.6	V