

A-703 and AH-703 Series, Rated up to 400 Amps, 28 Vdc*

Product Facts

- SPST NO, Double break
- Gasket sealed or Hermetically sealed
- Auxiliary contacts available
- Meets many requirements of MIL-PRF-6106



Performance Data

Electrical Characteristics

Contact Arrangement —

SPST NO, Double Break

Rated Operating Voltage —

28 Vdc* Except for A-703CSM which is 36/40 Vdc

Resistive Rating — 400 Amps

Resistive for 30 sec — 1,000 Amps

Inrush Rating — 1,500 Amps

General Characteristics

Temperature Range —

-55°C to +71°C

Operating Cycles (Life) at Rated

Resistive Load, Min. — 50,000 cycles

Operating Cycles (Life)

Mechanical, Min. — 100,000 cycles

Dielectric Strength —

All Circuits to Ground — 1,250 Vrms

Circuit to Circuit — 1,250 Vrms

Coil to Ground and Aux. Contacts — 1,000 Vrms

Weight — 2.12 to 2.88 lbs

Pickup Time, @ Nom. Voltage,

Max. — 35 msec

Dropout Time, @ Nom. Voltage,

Max. — 35 msec

Bounce Time, @ Nom. Voltage,

Max. — .004 msec

Coil Characteristics

Duty Cycle —

Intermittent (Type A, See diagram below), Intermittent with suppression (Type B, See diagram below), Continuous, economized (Type C, See diagram below) or Continuous, economized with suppression (Type D, See diagram below)

Operating Voltage —

28 Vdc Nominal

Pickup Voltage @ 25°C, Max. —

A-703B — 8 Vdc

A-703DBH — 10 Vdc

A-703, A-703CD, A-703CSM, A-703D,

A-703FA, A-703FB, A-703FSS,

A-703ZS — 12 Vdc

A-703T — 13 Vdc

AH-703F, A-703E, A-703G-1, A-703GC,

A-703GS, A-703R, AH-703F — 16 Vdc

Dropout Voltage —

A-703B — 0.5 to 3 Vdc

A-703CD, A-703FA, A-703FB —

0.5 to 5 Vdc

A-703T — 0.5 to 6 Vdc

A-703, A-703CSM, A-703D, A-703FSS,

A-703ZS — 0.5 to 7 Vdc

A-703DBH, A-703E, A-703R —

1.0 to 7 Vdc

AH-703F, A-703G-1, A-703GC, A-

703GS, AH-703F — 1.5 to 7 Vdc

For factory-direct application assistance, phone 419-521-9500 or fax 419-526-2749.

A-703 and AH-703 Series, Rated up to 400 Amps, 28 Vdc (Continued)

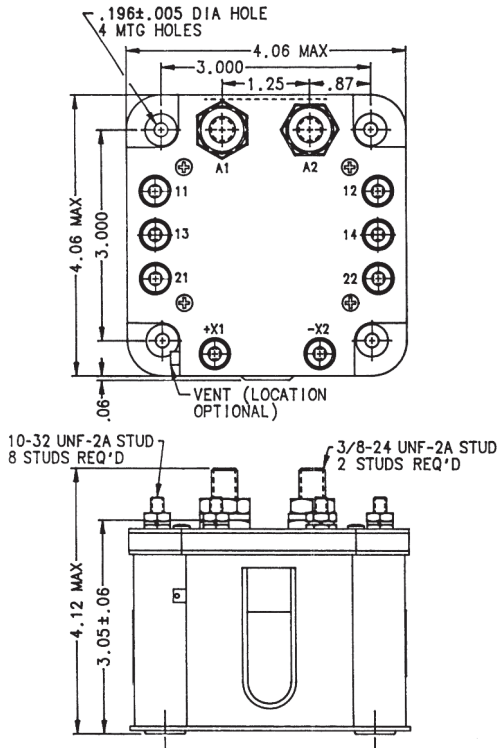

Mounting Style A

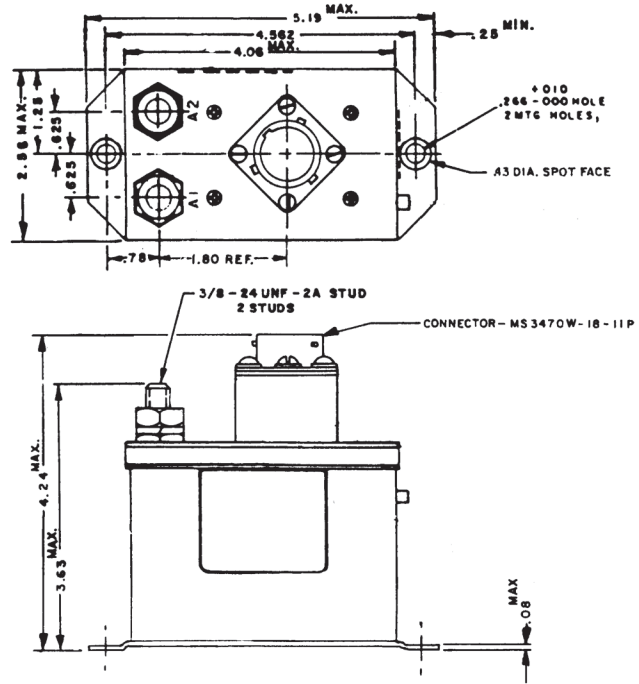

Mounting Style B

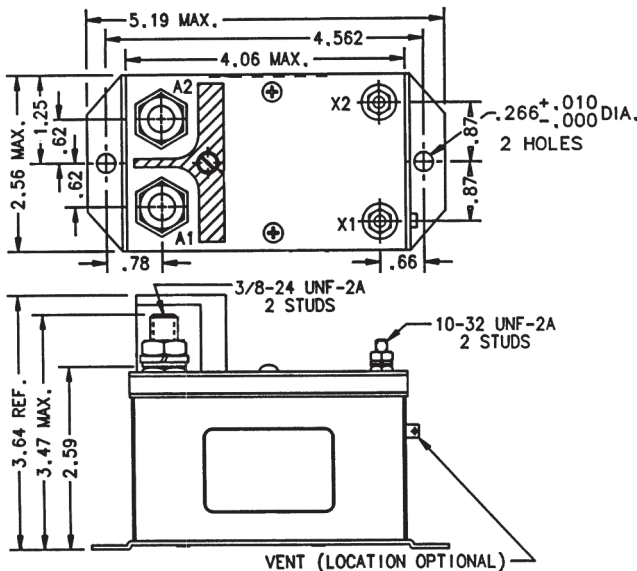

Mounting Style C

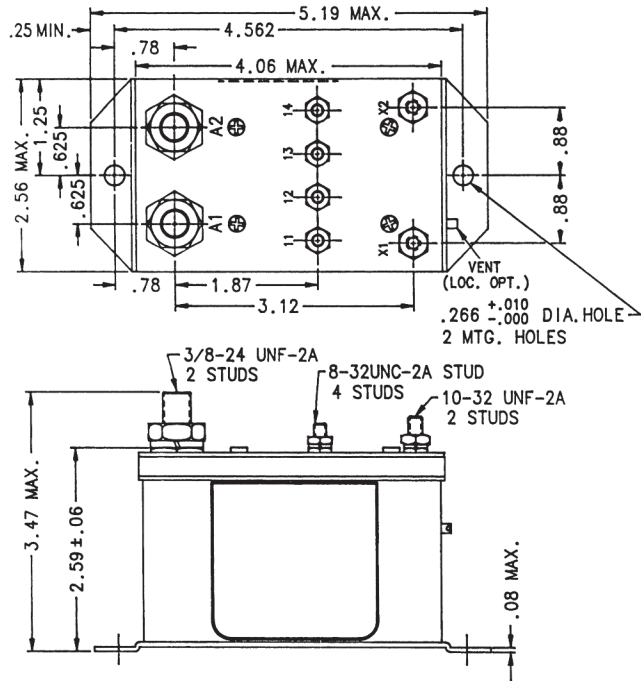

Mounting Style D

6 HARTMAN Power Switching DC Contactors

For factory-direct application assistance, phone 419-521-9500 or fax 419-526-2749.

A-703 and AH-703 Series, Rated up to 400 Amps, 28 Vdc (Continued)

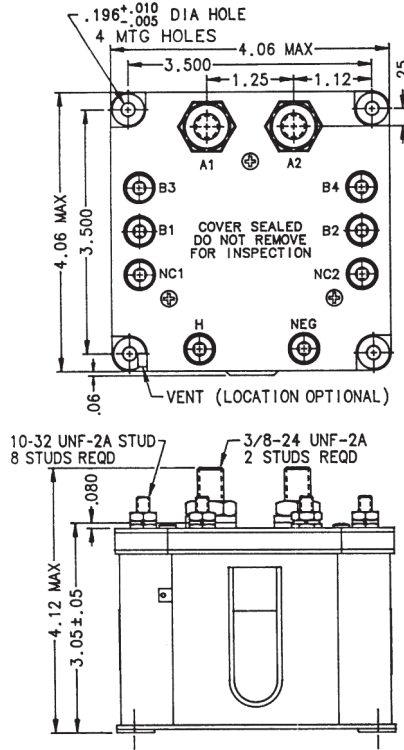

Mounting Style E

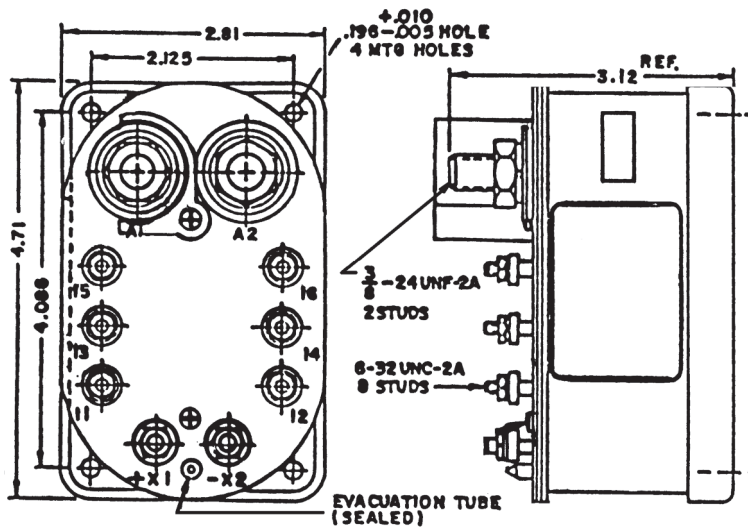

Mounting Style F

For factory-direct application assistance, phone 419-521-9500 or fax 419-526-2749.

A-703 and AH-703 Series, Rated up to 400 Amps, 28 Vdc (Continued)

Circuit Configurations (Consult factory for other available circuit configurations)

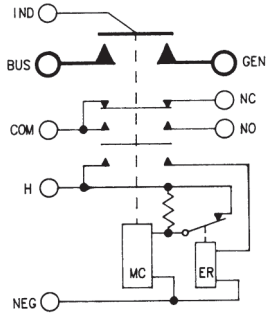

Circuit Configuration 1

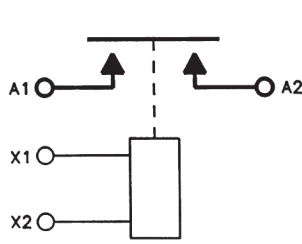

Circuit Configuration 2

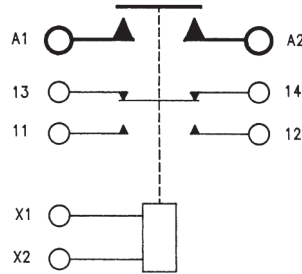

Circuit Configuration 3

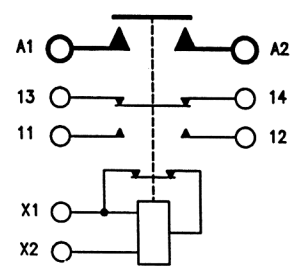

Circuit Configuration 4

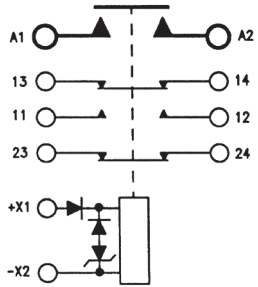

Circuit Configuration 5

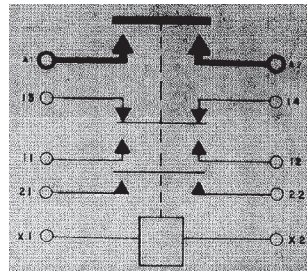

Circuit Configuration 6

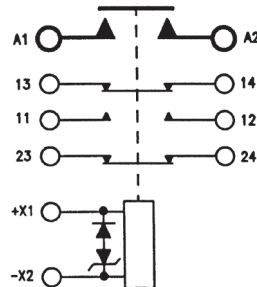

Circuit Configuration 7

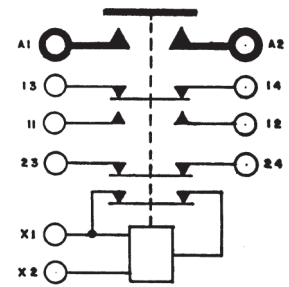

Circuit Configuration 8

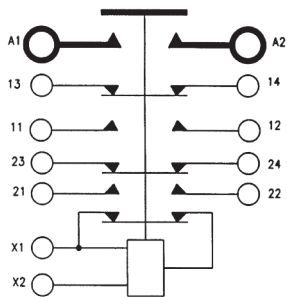

Circuit Configuration 9

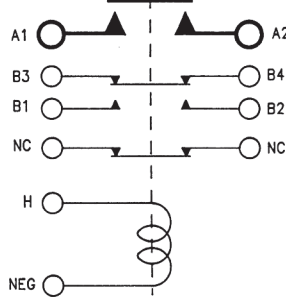

Circuit Configuration 10

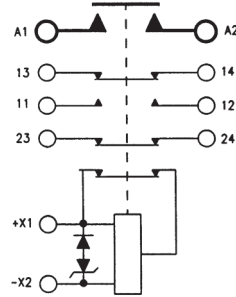

Circuit Configuration 11

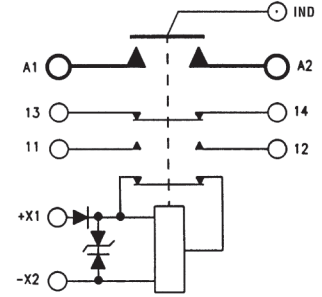

Circuit Configuration 12

For factory-direct application assistance, phone 419-521-9500 or fax 419-526-2749.

A-703 and AH-703 Series, Rated up to 400 Amps, 28 Vdc (Continued)

Circuit Configurations (Consult factory for other available circuit configurations)

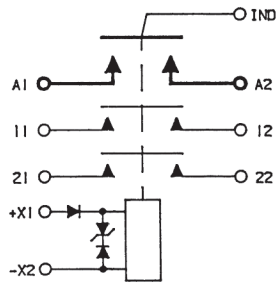

Circuit Configuration 13

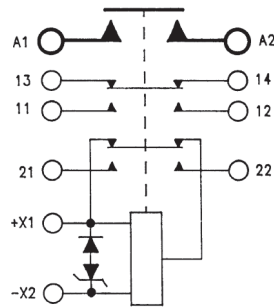

Circuit Configuration 14

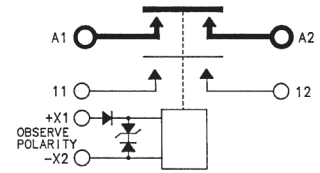

Circuit Configuration 15

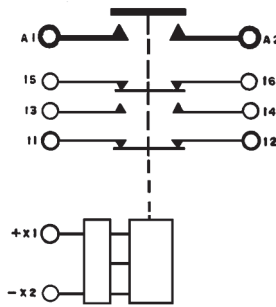

Circuit Configuration 16

HARTMAN Part Number	Construction Type	Mounting Style	Coil Type	Circuit Config.	TE Part Number
A-703	Gasket/Vented	A	Continuous, Economized	1	1616058-1
A-703CD	Gasket/Vented	C	Intermittent	2	1616058-6
A-703CSM	Gasket/Vented	D	Intermittent	15	1616058-7
A-703D	Gasket/Vented	D	Intermittent	3	1616058-8
A-703DBH	Gasket/Vented	D	Intermittent	3	1-1616058-0
A-703E	Gasket/Vented	D	Continuous, Economized	4	1-1616058-1
A-703FA	Gasket/Vented	D	Intermittent w/Supp.	5	1-1616058-2
A-703FB	Gasket/Vented	D	Intermittent	6	1-1616058-3
A-703FSS	Gasket/Vented	D	Intermittent w/Supp.	7	1-1616058-4
A-703G-1	Gasket/Vented	D	Continuous, Economized	8	1-1616058-5
A-703GC	Gasket/Vented	D	Continuous, Economized	19	1-1616058-6
A-703B	Gasket/Vented	E	Intermittent	10	1616058-3
A-703GS	Gasket/Vented	D	Continuous, Economized w/Supp.	11	1-1616058-7
A-703R	Gasket/Vented	D	Continuous, Economized w/Supp.	12	1-1616058-9
A-703T	Gasket/Vented	D	Intermittent w/Supp.	13	2-1616058-0
A-703ZS	Gasket/Vented	A	Continuous, Economized w/Supp.	14	2-1616058-2
AH-703F	Hermetically Sealed	F	Continuous, Economized w/Supp.	16	1616061-1

For factory-direct application assistance, phone 419-521-9500 or fax 419-526-2749.