



AL20E-PM114S07

Ax20

ARRAY SENSORS

SICK
Sensor Intelligence.



Ordering information

Type	Part no.
AL20E-PM114S07	1062678

Other models and accessories → www.sick.com/Ax20



Detailed technical data

Features

Functional principle	Edge detection, reflector
Dimensions (W x H x D)	24.3 mm x 59.8 mm x 54.1 mm
Sensing distance	25 mm
Housing design (light emission)	Rectangular
Working range	20 mm ... 30 mm
Measurement range	20 mm
Minimum detectable object (MDO)	0.8 mm
Light source	LED, White
Wave length	400 nm ... 700 nm
Light spot size	30 mm x 5 mm
Reproducibility	0.03 mm ¹⁾
Linearity	± 2 % ²⁾

¹⁾ With respect to sensing distance.

²⁾ Analog current range (16 mA).

Mechanics/electronics

Supply voltage	≤ 24 V DC ¹⁾
Ripple	≤ 5 V ²⁾
Power consumption	< 3.1 W ³⁾
Switching output	PNP
Switching output (voltage)	PNP: HIGH = V _{S-} ≤ 2 V / LOW approx. 0 V
Analog output	4 mA ... 20 mA
Resolution of analog output	12 bit

¹⁾ ± 20 %. Operation in short-circuit protected network max. 8 A.

²⁾ May not exceed or fall below U_v tolerances.

³⁾ Without load.

⁴⁾ Typ. max. 1.6 s.

Output rate of analog output	1 ms
Output current I_{max.}	< 100 mA
Initialization time	0.48 s ⁴⁾
Multifunctional input MF	Teach-in on reflector from multifunction input from 15 s after booting
Connection type	Male connector M12, 5-pin
Protection class	III
Circuit protection	U _V connections, reverse polarity protected Output Q short-circuit protected Interference pulse suppression
Enclosure rating	IP67
Weight	135 g
Housing material	Metal

1) ± 20 %. Operation in short-circuit protected network max. 8 A.

2) May not exceed or fall below U_V tolerances.

3) Without load.

4) Typ. max. 1.6 s.

Ambient data

Ambient operating temperature	-10 °C ... +55 °C
Ambient storage temperature	-25 °C ... +75 °C
Shock load	According to IEC 60068
UL File No.	NRKH.E181493 & NRKH7.E181493

Classifications

ECl@ss 5.0	27310205
ECl@ss 5.1.4	27310205
ECl@ss 6.0	27310205
ECl@ss 6.2	27310205
ECl@ss 7.0	27310205
ECl@ss 8.0	27310205
ECl@ss 8.1	27310205
ECl@ss 9.0	27310205
ETIM 5.0	EC001825
ETIM 6.0	EC001825
UNSPSC 16.0901	43211731

Dimensional drawing (Dimensions in mm (inch))

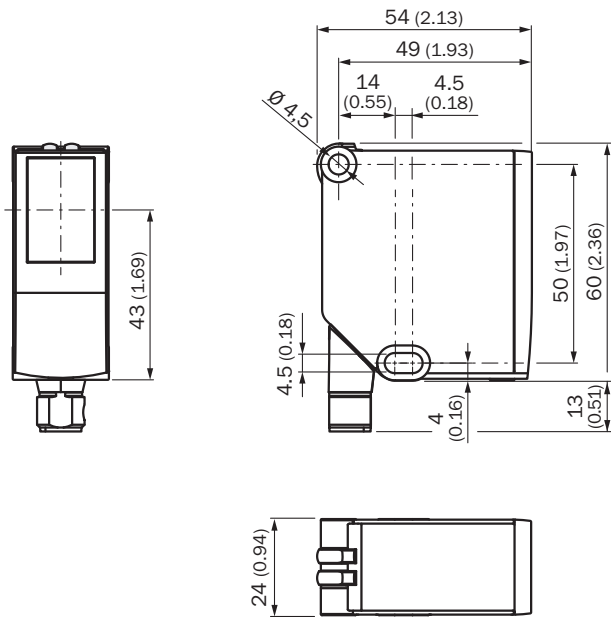

Connection diagram

cd-348

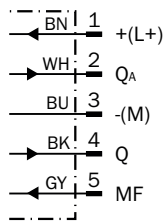

Concept of operation

Explanation of parameters

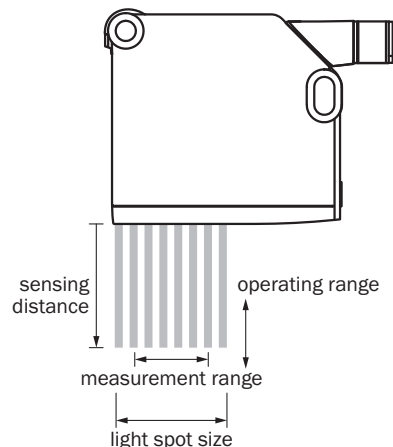



Sensing distance	Operating range	Measurement range	Light spot size
25 mm	20 mm ... 30 mm	20 mm	30 mm x 5 mm
100 mm	90 mm ... 110 mm	30 mm	50 mm x 10 mm

Recommended accessories

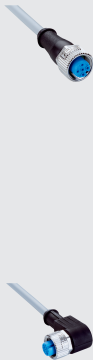
Other models and accessories → www.sick.com/Ax20

	Brief description	Type	Part no.
Mounting brackets and plates			
	Mounting bracket, stainless steel, without mounting material, for DT20 Hi, without mounting hardware	BEF-WN-DT20	4043524
Plug connectors and cables			
	Head A: female connector, M12, 5-pin, straight, A-coded Head B: Flying leads Cable: Sensor/actuator cable, PVC, unshielded, 2 m	YF2A15-020VB5XLEAX	2096239
	Head A: female connector, M12, 5-pin, straight, A-coded Head B: Flying leads Cable: Sensor/actuator cable, PVC, unshielded, 5 m	YF2A15-050VB5XLEAX	2096240
	Head A: female connector, M12, 5-pin, straight, A-coded Head B: Flying leads Cable: Sensor/actuator cable, PVC, unshielded, 10 m	YF2A15-100VB5XLEAX	2096241
	Head A: female connector, M12, 5-pin, angled, A-coded Head B: Flying leads Cable: Sensor/actuator cable, PVC, unshielded, 2 m	YG2A15-020VB5XLEAX	2096215
	Head A: female connector, M12, 5-pin, angled, A-coded Head B: Flying leads Cable: Sensor/actuator cable, PVC, unshielded, 5 m	YG2A15-050VB5XLEAX	2096216
	Head A: female connector, M12, 5-pin, angled, A-coded Head B: Flying leads Cable: Sensor/actuator cable, PVC, unshielded, 10 m	YG2A15-100VB5XLEAX	2096217

	Brief description	Type	Part no.
	Head A: female connector, M12, 5-pin, straight Cable: unshielded	DOS-1205-G	6009719
	Head A: female connector, M12, 5-pin, angled Head B: - Cable: unshielded	DOS-1205-W	6009720

SICK AT A GLANCE

SICK is one of the leading manufacturers of intelligent sensors and sensor solutions for industrial applications. A unique range of products and services creates the perfect basis for controlling processes securely and efficiently, protecting individuals from accidents and preventing damage to the environment.

We have extensive experience in a wide range of industries and understand their processes and requirements. With intelligent sensors, we can deliver exactly what our customers need. In application centers in Europe, Asia and North America, system solutions are tested and optimized in accordance with customer specifications. All this makes us a reliable supplier and development partner.

Comprehensive services complete our offering: SICK LifeTime Services provide support throughout the machine life cycle and ensure safety and productivity.

For us, that is “Sensor Intelligence.”

WORLDWIDE PRESENCE:

Contacts and other locations –www.sick.com